

Job#

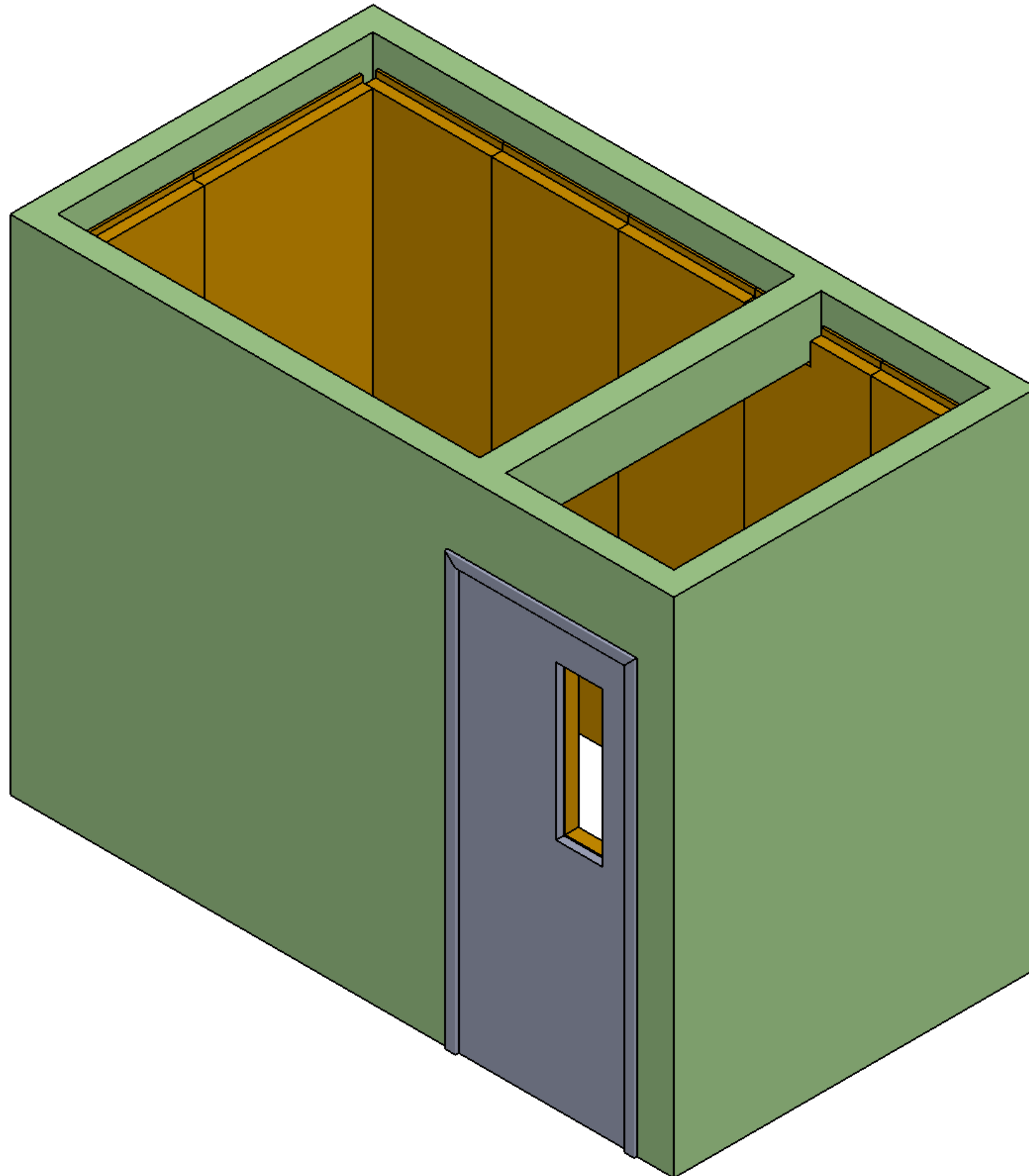

THIS DRAWING AND ALL INFORMATION CONTAINED HEREIN IS THE PROPERTY OF SPORT SYSTEMS CANADA INC. AND IS NOT TO BE REPRODUCED WITHOUT THE WRITTEN PERMISSION OF THIS MANUFACTURER. WE ASSUME NO RESPONSIBILITY FOR UNAUTHORIZED USE OF THIS DRAWING. SPORT SYSTEMS CANADA INC. IS NOT RESPONSIBLE FOR LOCAL PERMITS AND OCCUPANCY REQUIREMENTS.



Building a Better Game

28 Industrial Drive, Box 940  
Almonte, Ontario, Canada  
K0A 1A0

www.ssci.ca  
1.877.600.4667  
T 613.256.1112  
F 613.256.5876

CLIENT

TITLE  
**PADDED ROOM**

REV.	DATE	Drawing No:
03	May 14/2014	72282-01-1

SCALE	DES.	PAGE
N.T.S.	John Cox	1 of 12

Job#

BILL OF MATERIAL

ITEM NO.	PART NUMBER	DESCRIPTION	QTY.
5	DP-29-77	CUSTOM DOOR PAD 29" x 77"	1
6	WP-24-89	CUSTOM WALL PAD 24" x 89"	7
7	WP-C-24-89	CUSTOM WALL PAD 24" x 89" WITH CUTOUT	1
8	WP-17.5-89	CUSTOM WALL PAD 17-1/2" x 89"	1
9	WP-34-89	CUSTOM WALL PAD 34" x 89"	1
10	WP-32-89	CUSTOM WALL PAD 32" x 89"	1
11	WP-27.75-89	CUSTOM WALL PAD 27-3/4" x 89"	1

D

C

B

A

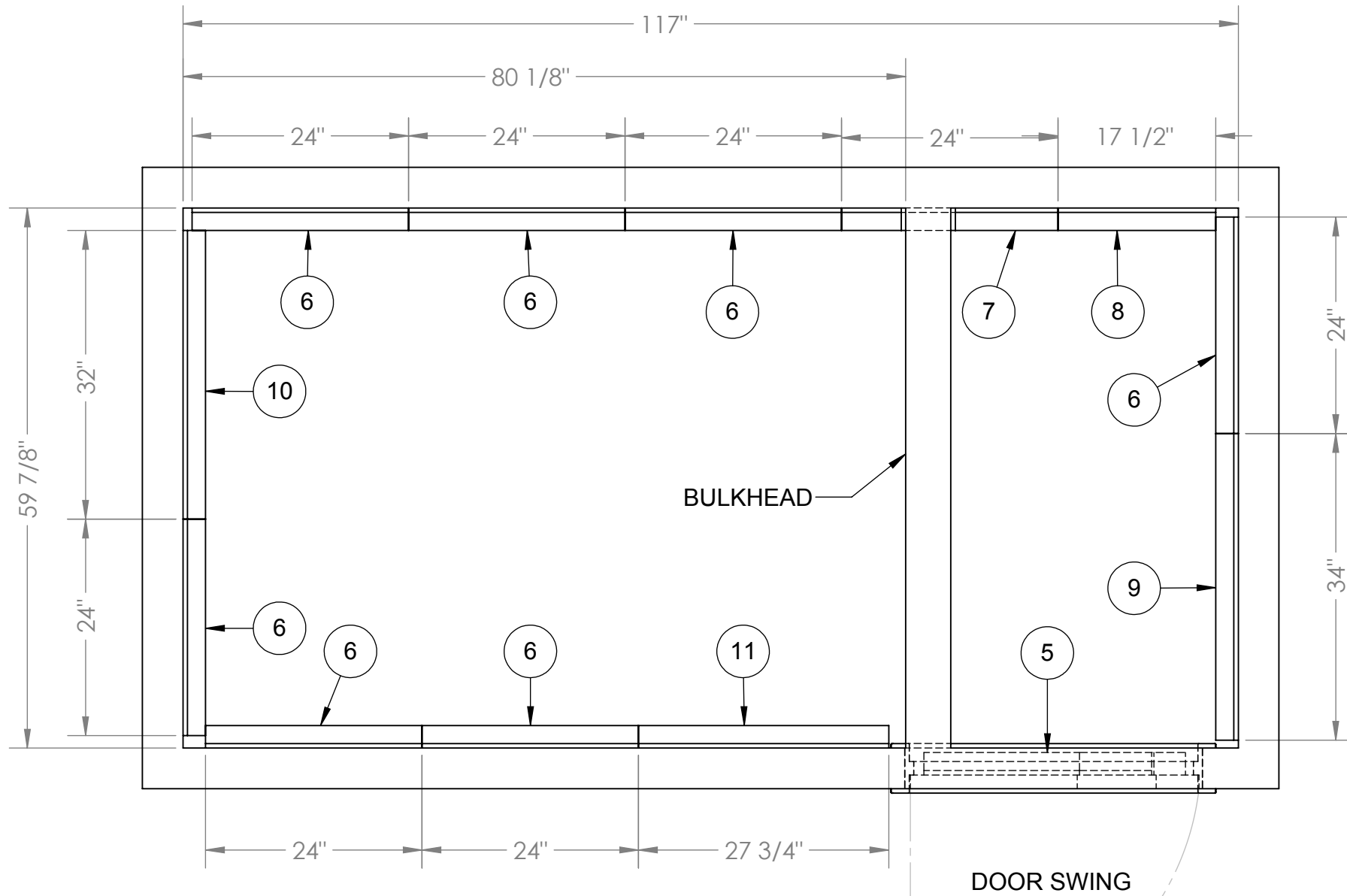

PLAN VIEW

DOOR SWING

BULKHEAD

**PROPRIETARY AND CONFIDENTIAL**  
 THE INFORMATION CONTAINED IN THIS DRAWING IS THE SOLE PROPERTY OF <INSERT COMPANY NAME HERE>. ANY REPRODUCTION IN PART OR AS A WHOLE WITHOUT THE WRITTEN PERMISSION OF <INSERT COMPANY NAME HERE> IS PROHIBITED.

UNLESS OTHERWISE SPECIFIED:		NAME	DATE
DIMENSIONS ARE IN INCHES		DRAWN	JC 05/14/2014
TOLERANCES:		CHECKED	
FRACTIONAL ±		ENG APPR.	
ANGULAR: MACH ± BEND ±		MFG APPR.	
TWO PLACE DECIMAL ±		Q.A.	
THREE PLACE DECIMAL ±		COMMENTS:	
INTERPRET GEOMETRIC TOLERANCING PER:			
MATERIAL			
FINISH			
NEXT ASSY	USED ON		
APPLICATION			
DO NOT SCALE DRAWING			

<b>WALL PADS MAIN SAFE ROOM</b>		
SIZE	DWG. NO.	REV
<b>B</b>	72282-01-1	03
SCALE: 1:32 WEIGHT:		SHEET 2 OF 13

D

C

B

A

8 7 6 5 4 3 2 1

8 7 6 5 4 3 2 1

Job#

NOTES:  
SEE SHEET 2 FOR BALLOON ITEM QUANTITIES

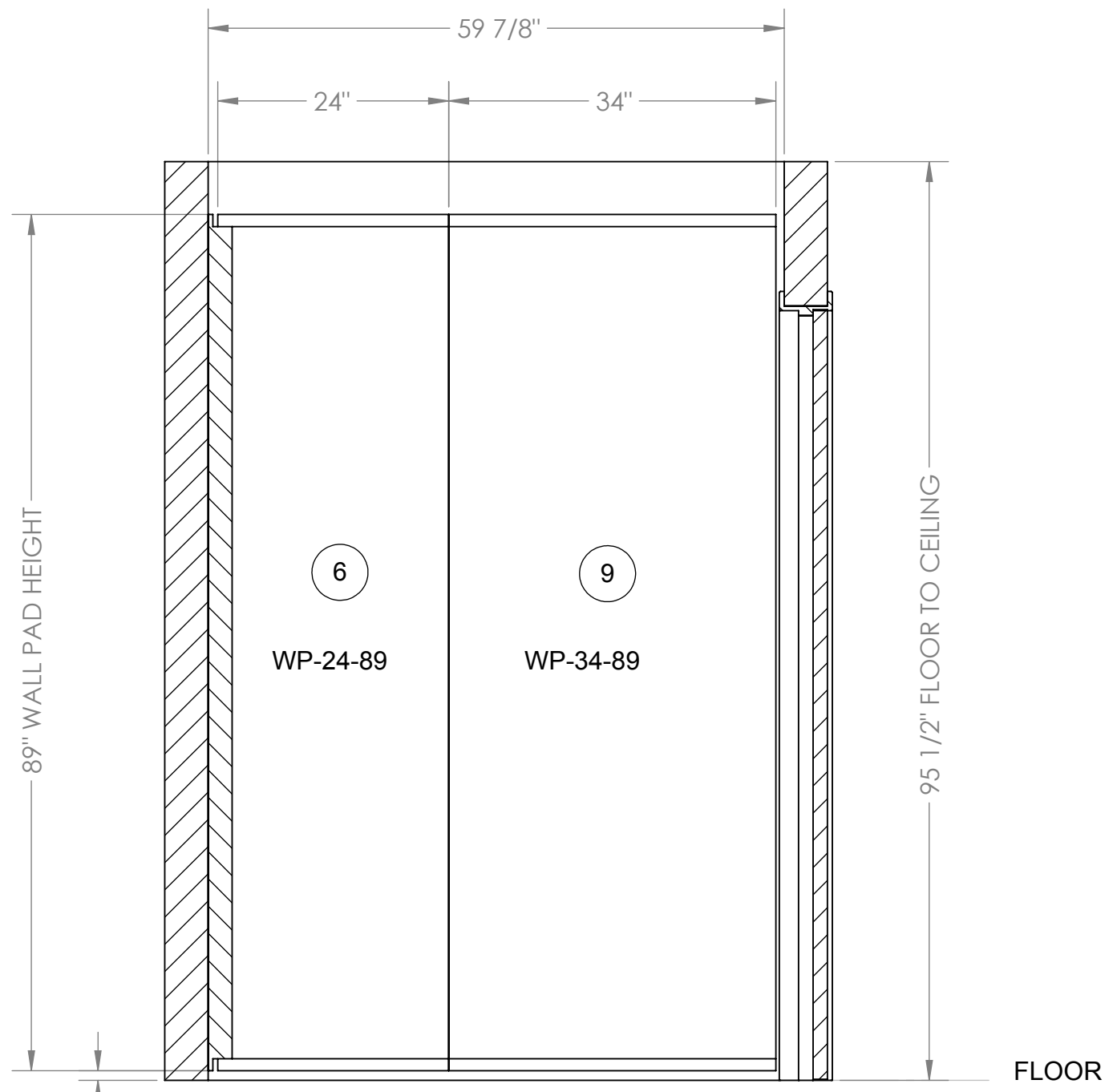

ELEVATION RIGHT WALL  
SCALE 1 : 16

**PROPRIETARY AND CONFIDENTIAL**  
THE INFORMATION CONTAINED IN THIS DRAWING IS THE SOLE PROPERTY OF <INSERT COMPANY NAME HERE>. ANY REPRODUCTION IN PART OR AS A WHOLE WITHOUT THE WRITTEN PERMISSION OF <INSERT COMPANY NAME HERE> IS PROHIBITED.

		UNLESS OTHERWISE SPECIFIED:	NAME	DATE
		DIMENSIONS ARE IN INCHES	DRAWN	JC
		TOLERANCES:	CHECKED	05/14/2014
		FRACTIONAL ±	ENG APPR.	
		ANGULAR: MACH ± BEND ±	MFG APPR.	
		TWO PLACE DECIMAL ±	Q.A.	
		THREE PLACE DECIMAL ±	COMMENTS:	
		INTERPRET GEOMETRIC TOLERANCING PER:		
		MATERIAL		
NEXT ASSY	USED ON	FINISH		
APPLICATION		DO NOT SCALE DRAWING		

<b>WALL PADS MAIN SAFE ROOM</b>		
SIZE	DWG. NO.	REV
<b>B</b>	72282-01-1	03
SCALE: 1:32 WEIGHT:		SHEET 3 OF 13

Job#

NOTES:  
SEE SHEET 2 FOR BALLOON ITEM QUANTITIES

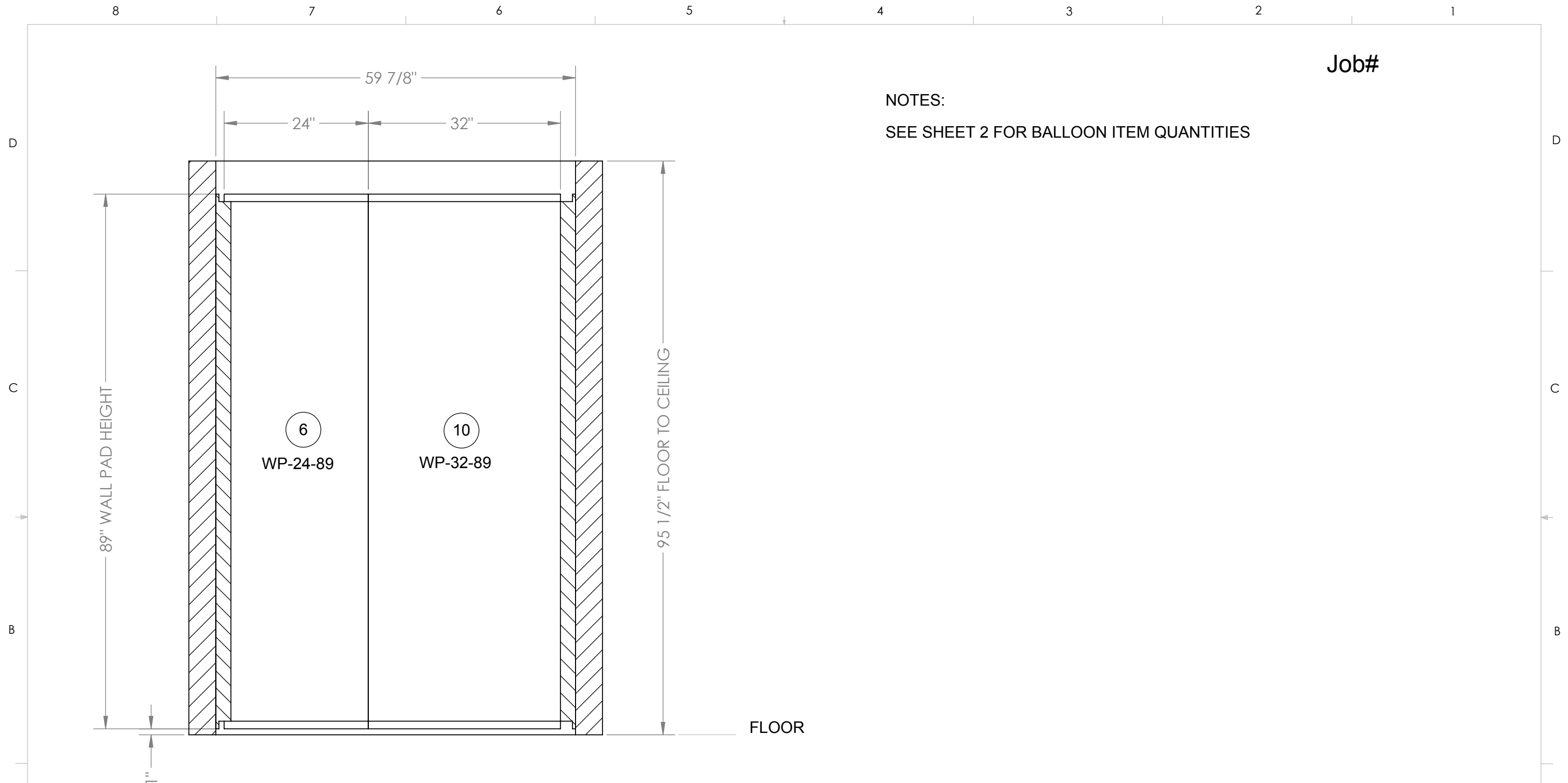

ELEVATION LEFT WALL  
SCALE 1 : 16

**PROPRIETARY AND CONFIDENTIAL**  
THE INFORMATION CONTAINED IN THIS DRAWING IS THE SOLE PROPERTY OF <INSERT COMPANY NAME HERE>. ANY REPRODUCTION IN PART OR AS A WHOLE WITHOUT THE WRITTEN PERMISSION OF <INSERT COMPANY NAME HERE> IS PROHIBITED.

		UNLESS OTHERWISE SPECIFIED:	NAME	DATE		
		DIMENSIONS ARE IN INCHES	DRAWN	JC	05/14/2014	<p style="text-align: center;"><b>WALL PADS MAIN SAFE ROOM</b></p>
		TOLERANCES:	CHECKED			
		FRACTIONAL ±	ENG APPR.			
		ANGULAR: MACH ± BEND ±	MFG APPR.			
		TWO PLACE DECIMAL ±	Q.A.			
		THREE PLACE DECIMAL ±	COMMENTS:			
		INTERPRET GEOMETRIC TOLERANCING PER:				
		MATERIAL				
NEXT ASSY	USED ON	FINISH				
APPLICATION		DO NOT SCALE DRAWING				
		SIZE <b>B</b>		DWG. NO.	REV	
				72282-01-1	03	
		SCALE: 1:32		WEIGHT:	SHEET 4 OF 13	

NOTES:

SEE SHEET 2 FOR BALLOON ITEM QUANTITIES

Job#

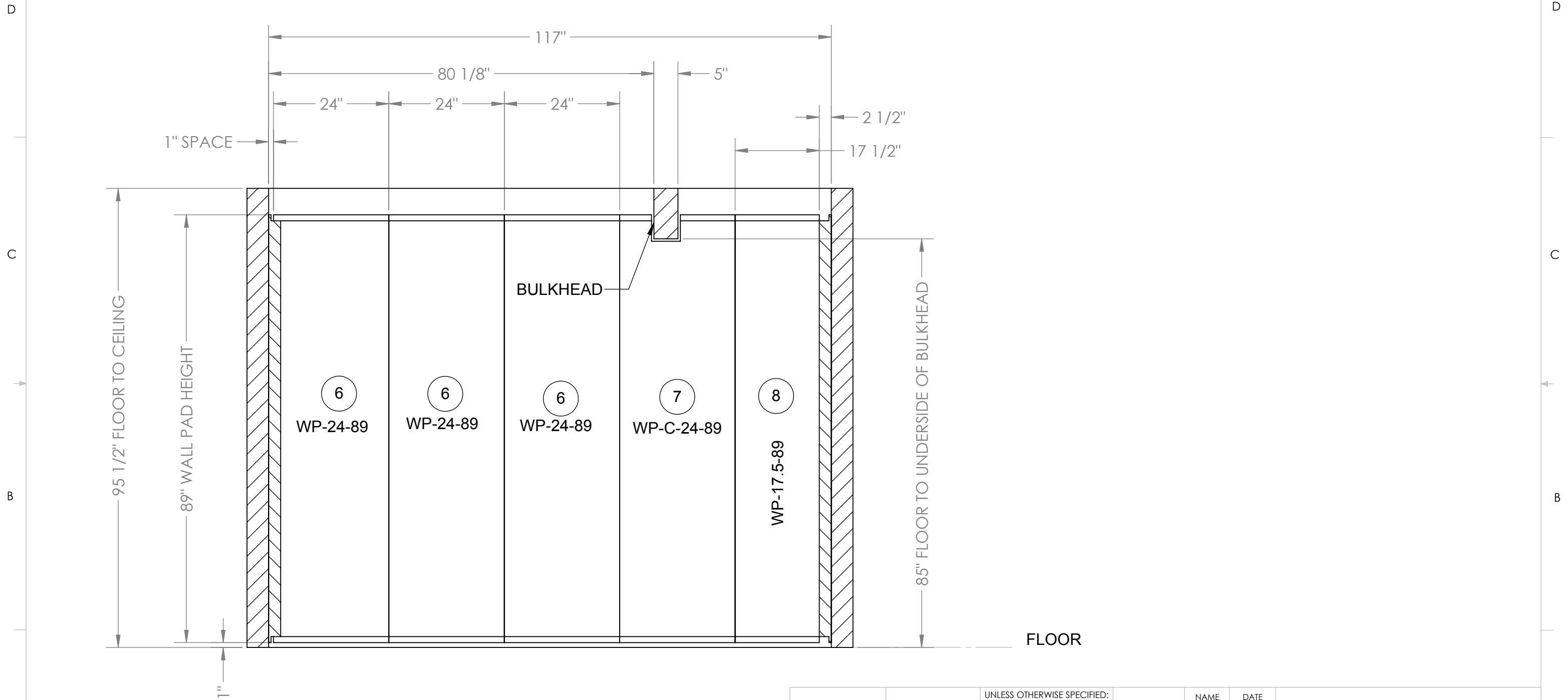

ELEVATION REAR WALL  
SCALE 1 : 20

**PROPRIETARY AND CONFIDENTIAL**  
THE INFORMATION CONTAINED IN THIS DRAWING IS THE SOLE PROPERTY OF <INSERT COMPANY NAME HERE>. ANY REPRODUCTION IN PART OR AS A WHOLE WITHOUT THE WRITTEN PERMISSION OF <INSERT COMPANY NAME HERE> IS PROHIBITED.

		UNLESS OTHERWISE SPECIFIED:		NAME	DATE
		DIMENSIONS ARE IN INCHES		DRAWN	JC 05/14/2014
		TOLERANCES:		CHECKED	
		FRACTIONAL ±		ENG APPR.	
		ANGULAR: MACH ± BEND ±		MFG APPR.	
		TWO PLACE DECIMAL ±		Q.A.	
		THREE PLACE DECIMAL ±		COMMENTS:	
		INTERPRET GEOMETRIC TOLERANCING PER:			
		MATERIAL			
NEXT ASSY	USED ON	FINISH			
APPLICATION		DO NOT SCALE DRAWING			
			<b>WALL PADS MAIN SAFE ROOM</b>		
			SCALE: 1:32 WEIGHT:		SHEET 5 OF 13

Job#

NOTES:

SEE SHEET 2 FOR BALLOON ITEM QUANTITIES

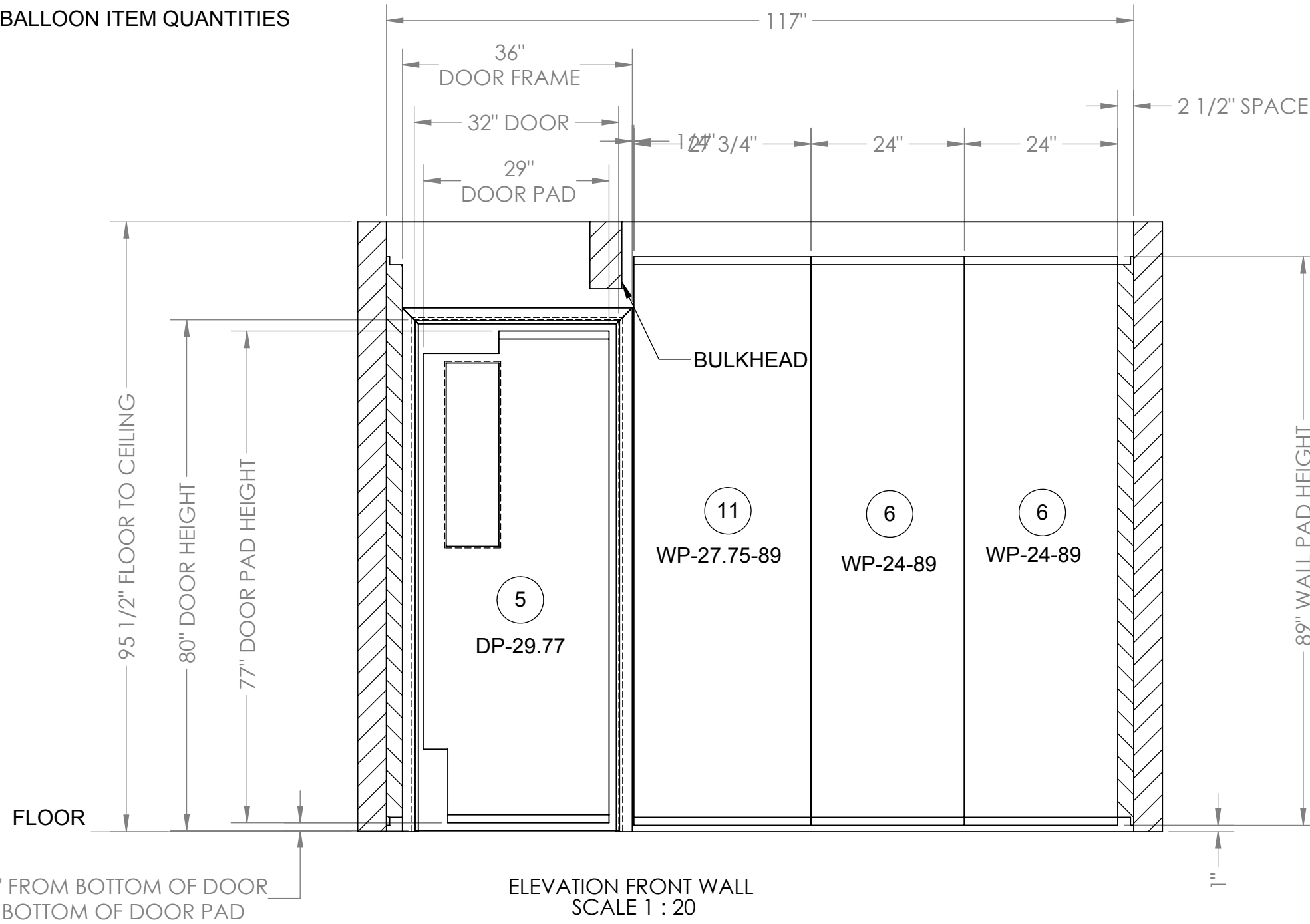

ELEVATION FRONT WALL  
SCALE 1 : 20

1 1/2" FROM BOTTOM OF DOOR  
TO BOTTOM OF DOOR PAD

**PROPRIETARY AND CONFIDENTIAL**  
THE INFORMATION CONTAINED IN THIS  
DRAWING IS THE SOLE PROPERTY OF  
<INSERT COMPANY NAME HERE>. ANY  
REPRODUCTION IN PART OR AS A WHOLE  
WITHOUT THE WRITTEN PERMISSION OF  
<INSERT COMPANY NAME HERE> IS  
PROHIBITED.

		UNLESS OTHERWISE SPECIFIED:	NAME	DATE
		DIMENSIONS ARE IN INCHES	DRAWN	JC
		TOLERANCES:	CHECKED	05/14/2014
		FRACTIONAL ±	ENG APPR.	
		ANGULAR: MACH ± BEND ±	MFG APPR.	
		TWO PLACE DECIMAL ±	Q.A.	
		THREE PLACE DECIMAL ±	COMMENTS:	
		INTERPRET GEOMETRIC TOLERANCING PER:		
		MATERIAL		
NEXT ASSY	USED ON	FINISH		
APPLICATION		DO NOT SCALE DRAWING		
			<b>WALL PADS MAIN SAFE ROOM</b>	
			SIZE <b>B</b>	DWG. NO. 72282-01-1
			SCALE: 1:32 WEIGHT:	
			SHEET 6 OF 13	

Job# QTY.1

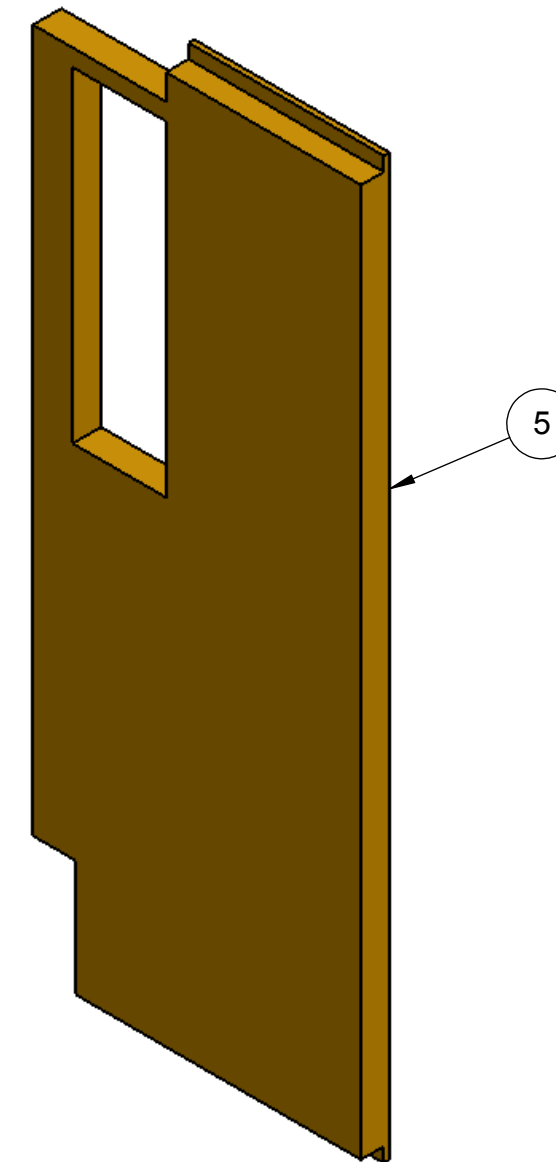
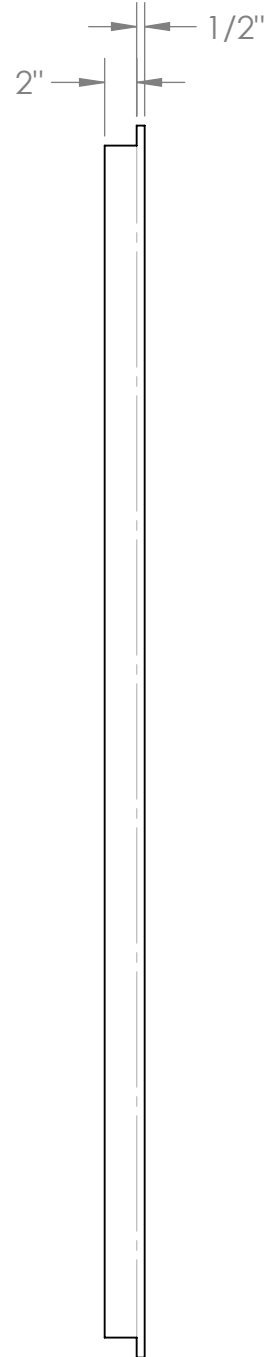
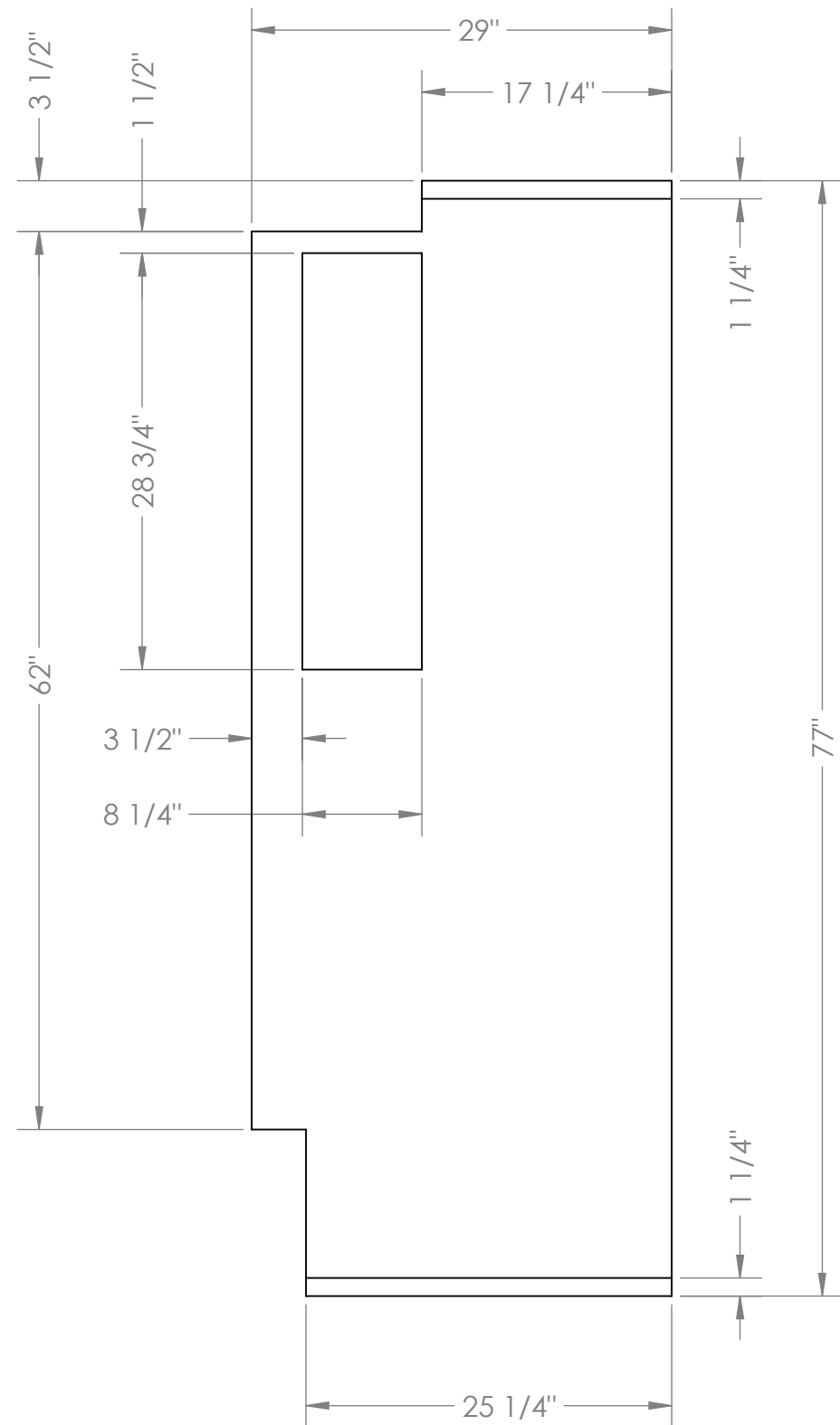

**PROPRIETARY AND CONFIDENTIAL**  
 THE INFORMATION CONTAINED IN THIS DRAWING IS THE SOLE PROPERTY OF <INSERT COMPANY NAME HERE>. ANY REPRODUCTION IN PART OR AS A WHOLE WITHOUT THE WRITTEN PERMISSION OF <INSERT COMPANY NAME HERE> IS PROHIBITED.

		UNLESS OTHERWISE SPECIFIED:		NAME	DATE
		DIMENSIONS ARE IN INCHES		DRAWN	JC 05/14/2014
		TOLERANCES:		CHECKED	
		FRACTIONAL ±		ENG APPR.	
		ANGULAR: MACH ± BEND ±		MFG APPR.	
		TWO PLACE DECIMAL ±		Q.A.	
		THREE PLACE DECIMAL ±		COMMENTS:	
		INTERPRET GEOMETRIC TOLERANCING PER:			
		MATERIAL			
		FINISH			
NEXT ASSY	USED ON				
APPLICATION		DO NOT SCALE DRAWING			
			CUSTOM DOOR PAD 29" x 77"		
			<b>B</b>	DP-29-77	03
			SCALE: 1:16	WEIGHT:	SHEET 7 OF 13

Job# QTY.8

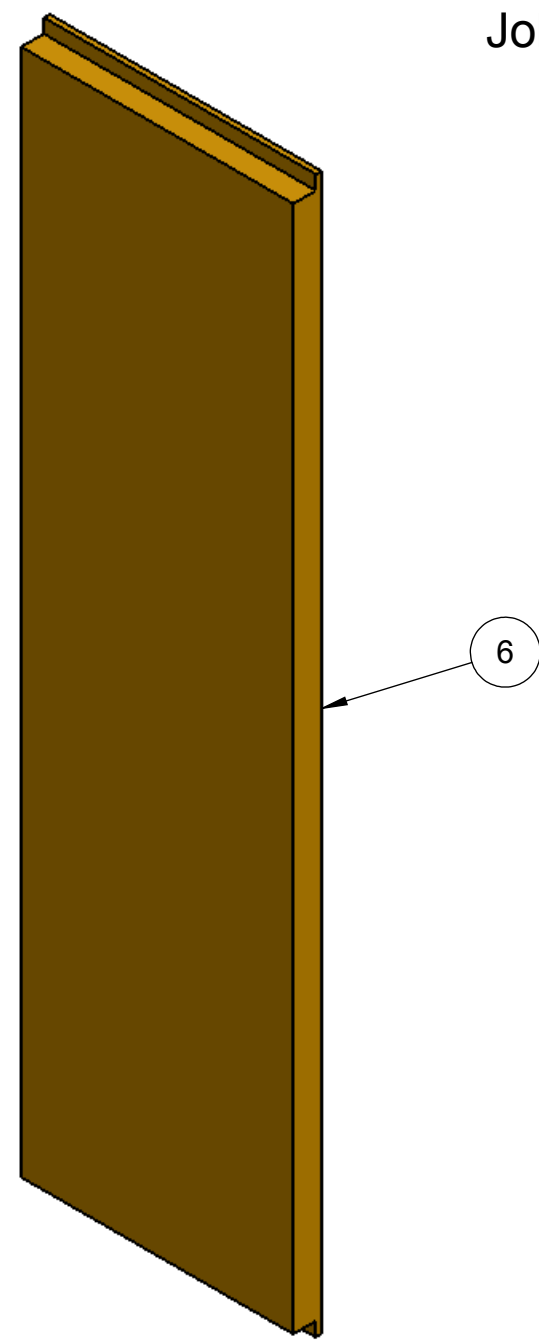
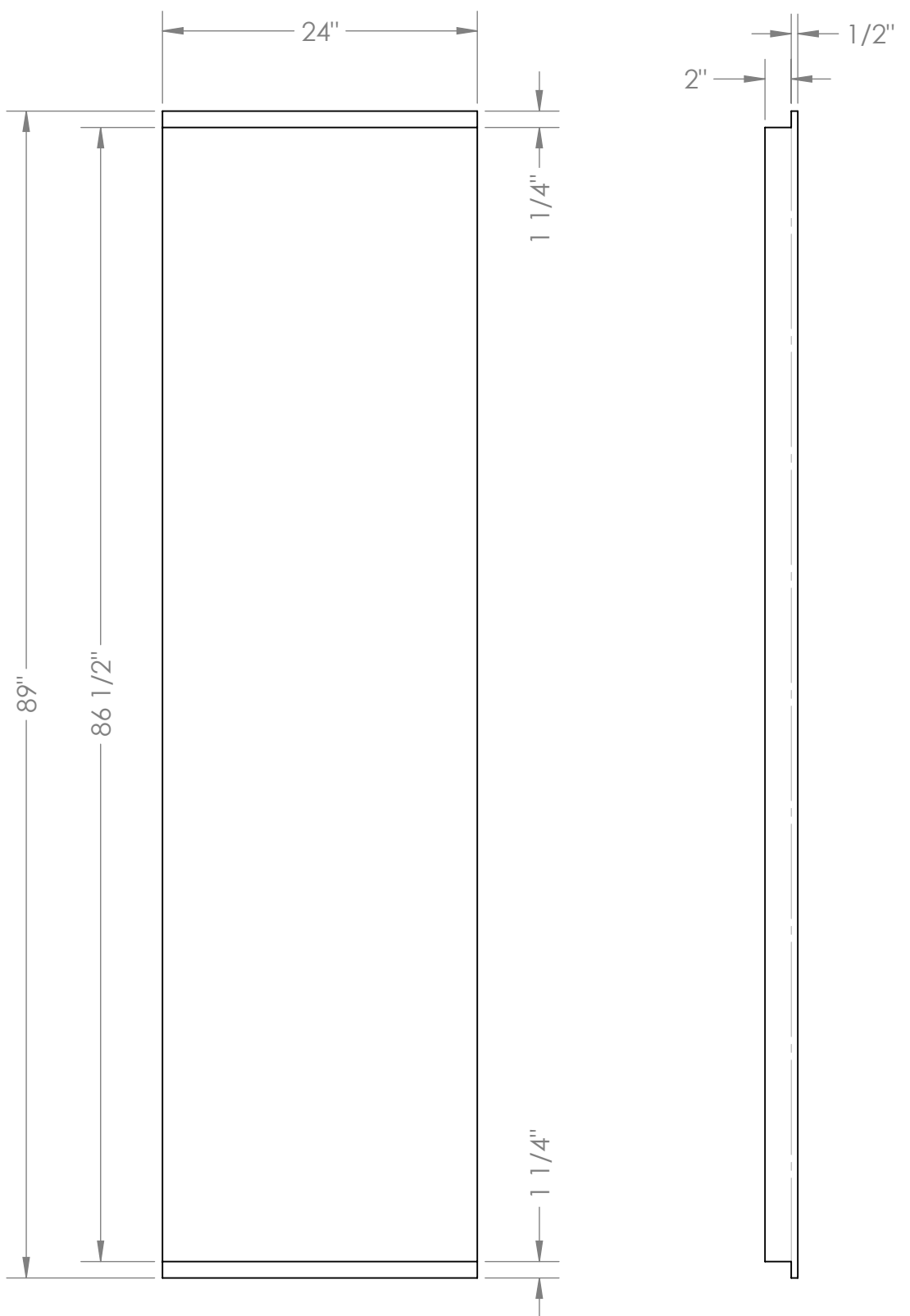

**PROPRIETARY AND CONFIDENTIAL**  
 THE INFORMATION CONTAINED IN THIS DRAWING IS THE SOLE PROPERTY OF <INSERT COMPANY NAME HERE>. ANY REPRODUCTION IN PART OR AS A WHOLE WITHOUT THE WRITTEN PERMISSION OF <INSERT COMPANY NAME HERE> IS PROHIBITED.

		UNLESS OTHERWISE SPECIFIED:		NAME	DATE
		DIMENSIONS ARE IN INCHES		DRAWN	JC 05/14/2014
		TOLERANCES:		CHECKED	
		FRACTIONAL ±		ENG APPR.	
		ANGULAR: MACH ± BEND ±		MFG APPR.	
		TWO PLACE DECIMAL ±		Q.A.	
		THREE PLACE DECIMAL ±		COMMENTS:	
		INTERPRET GEOMETRIC TOLERANCING PER:			
		MATERIAL			
NEXT ASSY	USED ON	FINISH			
APPLICATION		DO NOT SCALE DRAWING			

<b>CUSTOM WALL PAD</b> 24" x 89"		
SIZE	DWG. NO.	REV
<b>B</b>	<b>WP-24-89</b>	<b>03</b>
SCALE: 1:16 WEIGHT:		SHEET 8 OF 13



Job# QTY.1

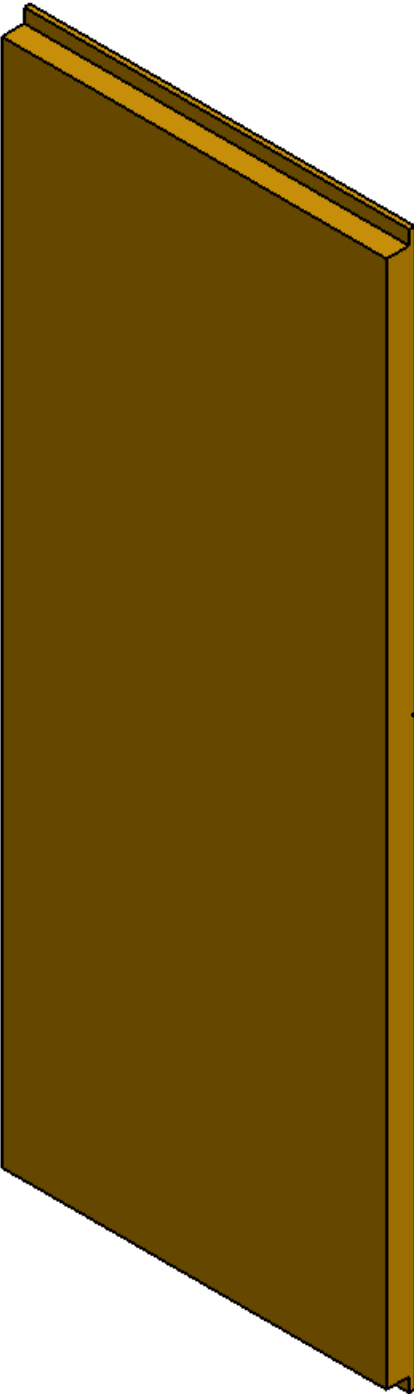
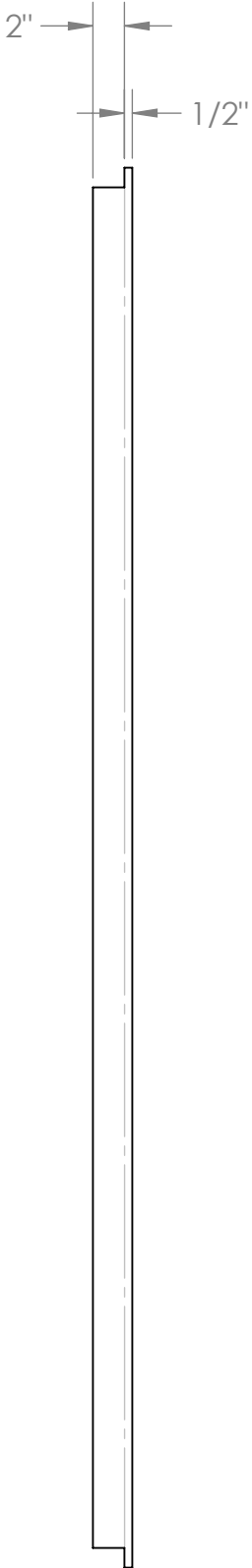
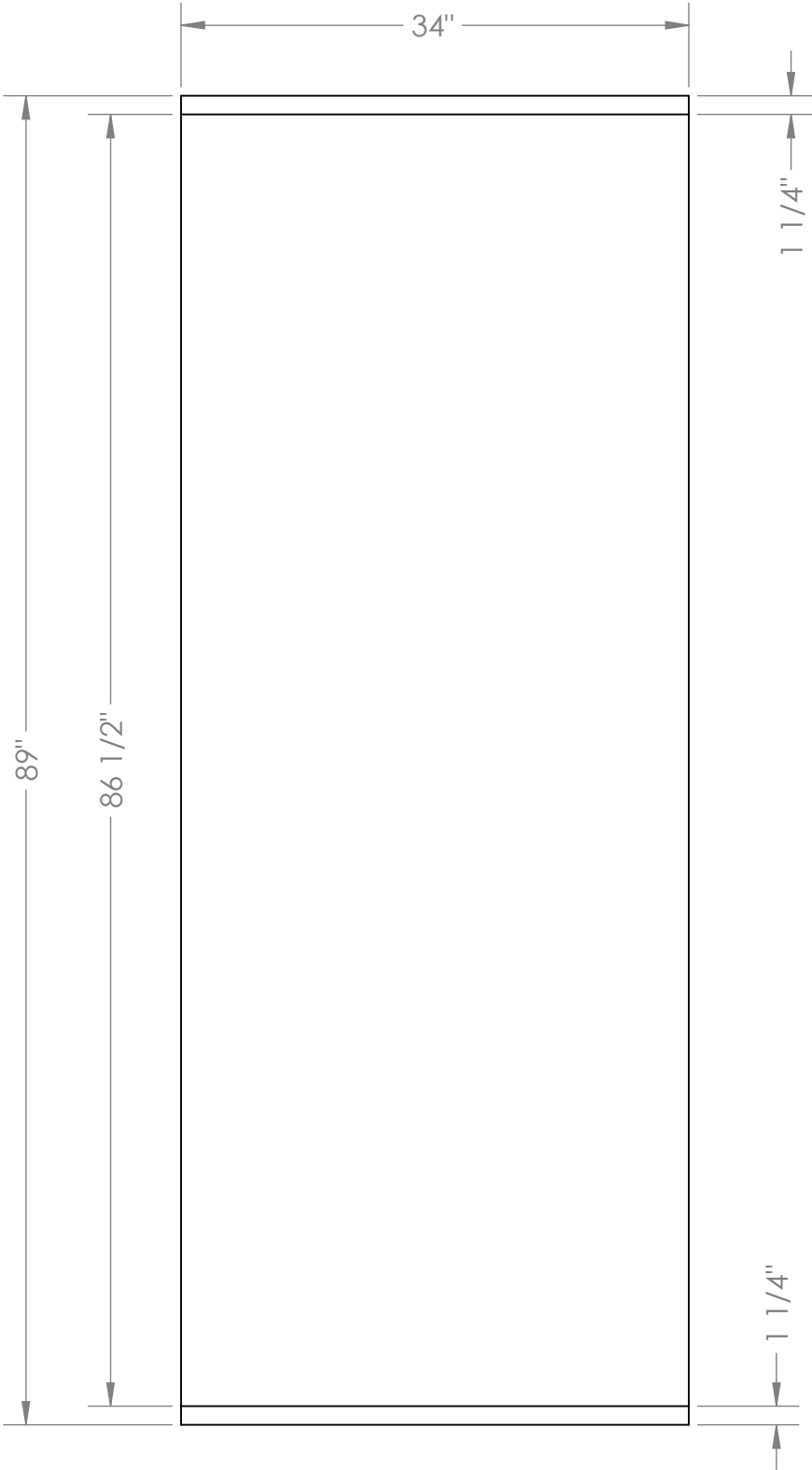

**PROPRIETARY AND CONFIDENTIAL**  
 THE INFORMATION CONTAINED IN THIS DRAWING IS THE SOLE PROPERTY OF <INSERT COMPANY NAME HERE>. ANY REPRODUCTION IN PART OR AS A WHOLE WITHOUT THE WRITTEN PERMISSION OF <INSERT COMPANY NAME HERE> IS PROHIBITED.

		UNLESS OTHERWISE SPECIFIED:		NAME	DATE
		DIMENSIONS ARE IN INCHES		DRAWN	JC 05/14/2014
		TOLERANCES:		CHECKED	
		FRACTIONAL ±		ENG APPR.	
		ANGULAR: MACH ± BEND ±		MFG APPR.	
		TWO PLACE DECIMAL ±		Q.A.	
		THREE PLACE DECIMAL ±		COMMENTS:	
		INTERPRET GEOMETRIC TOLERANCING PER:			
		MATERIAL			
NEXT ASSY	USED ON	FINISH			
APPLICATION		DO NOT SCALE DRAWING			
			CUSTOM WALL PAD 34" x 89"		
			<b>B</b>	WP-34-89	03
			SCALE: 1:16	WEIGHT:	SHEET 9 OF 13

Job# QTY.1

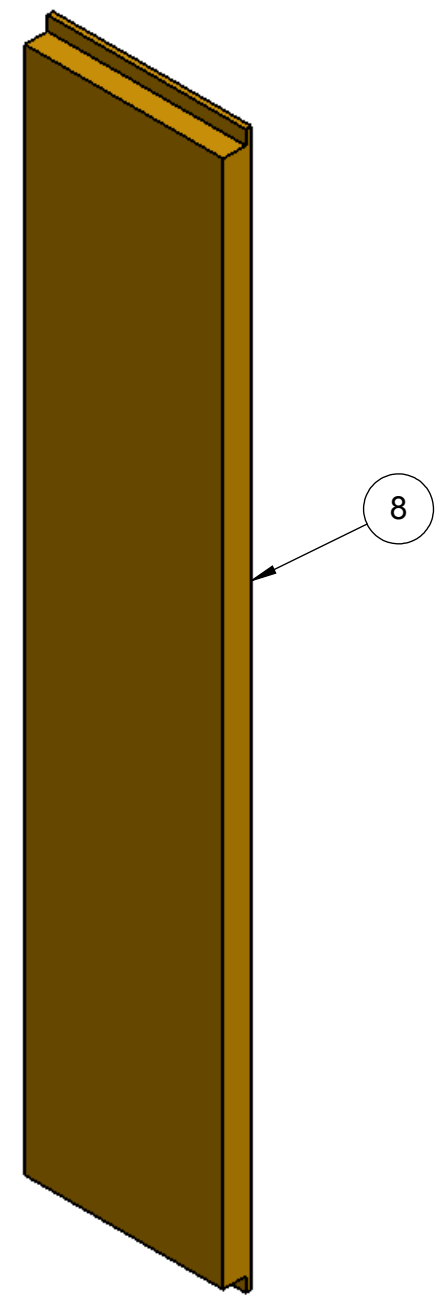
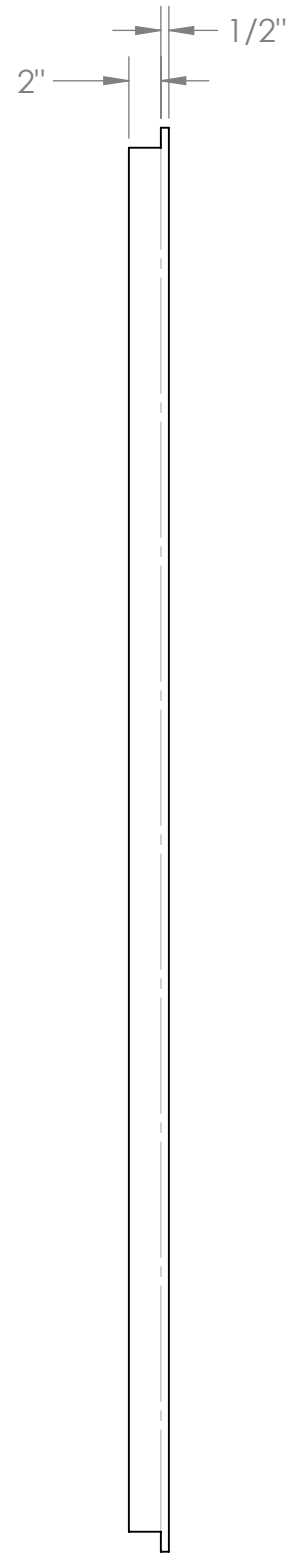
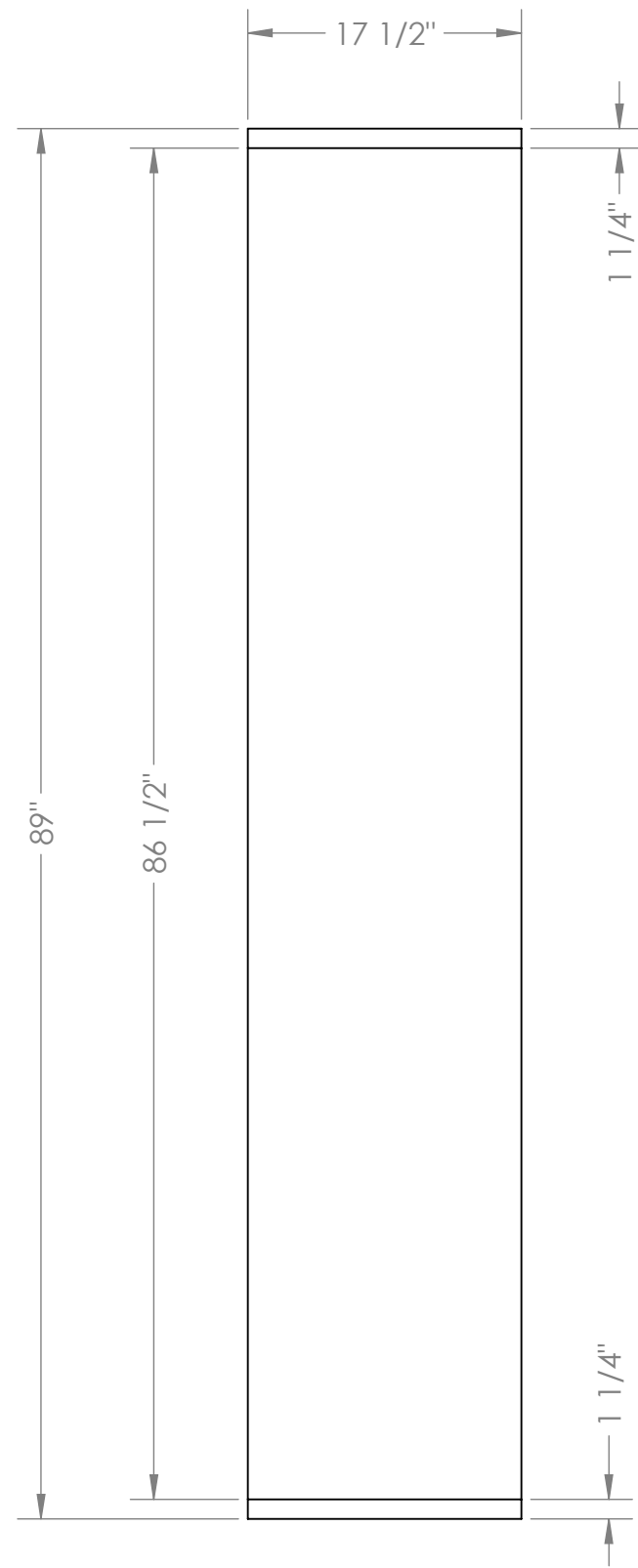

**PROPRIETARY AND CONFIDENTIAL**  
 THE INFORMATION CONTAINED IN THIS DRAWING IS THE SOLE PROPERTY OF <INSERT COMPANY NAME HERE>. ANY REPRODUCTION IN PART OR AS A WHOLE WITHOUT THE WRITTEN PERMISSION OF <INSERT COMPANY NAME HERE> IS PROHIBITED.

		UNLESS OTHERWISE SPECIFIED:		NAME	DATE
		DIMENSIONS ARE IN INCHES		DRAWN	JC 05/14/2014
		TOLERANCES:		CHECKED	
		FRACTIONAL ±		ENG APPR.	
		ANGULAR: MACH ± BEND ±		MFG APPR.	
		TWO PLACE DECIMAL ±		Q.A.	
		THREE PLACE DECIMAL ±		COMMENTS:	
		INTERPRET GEOMETRIC TOLERANCING PER:			
		MATERIAL			
NEXT ASSY	USED ON	FINISH			
APPLICATION		DO NOT SCALE DRAWING			
			<b>CUSTOM WALL PAD</b> 17-1/2" x 89"		
SIZE	DWG. NO.	REV			
<b>B</b>	WP-17.5-89	03			
SCALE: 1:16		WEIGHT:	SHEET 10 OF 13		

Job# QTY.1

D  
C  
B  
A

D  
C  
B  
A

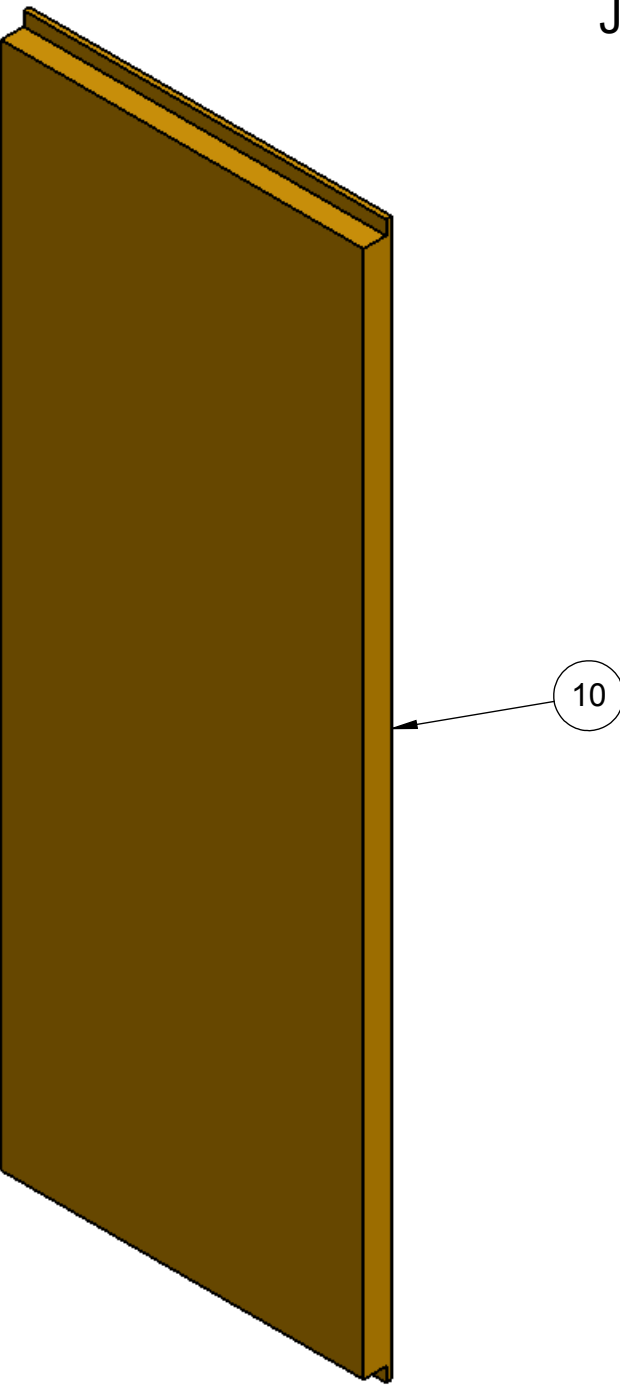
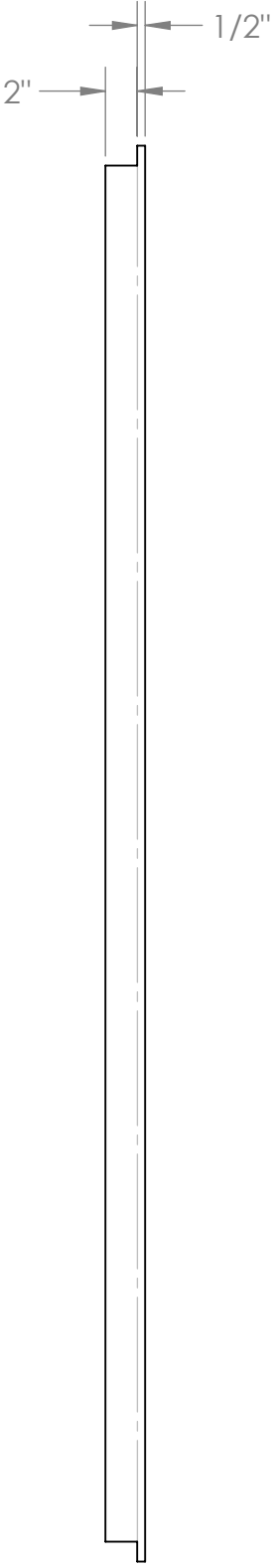
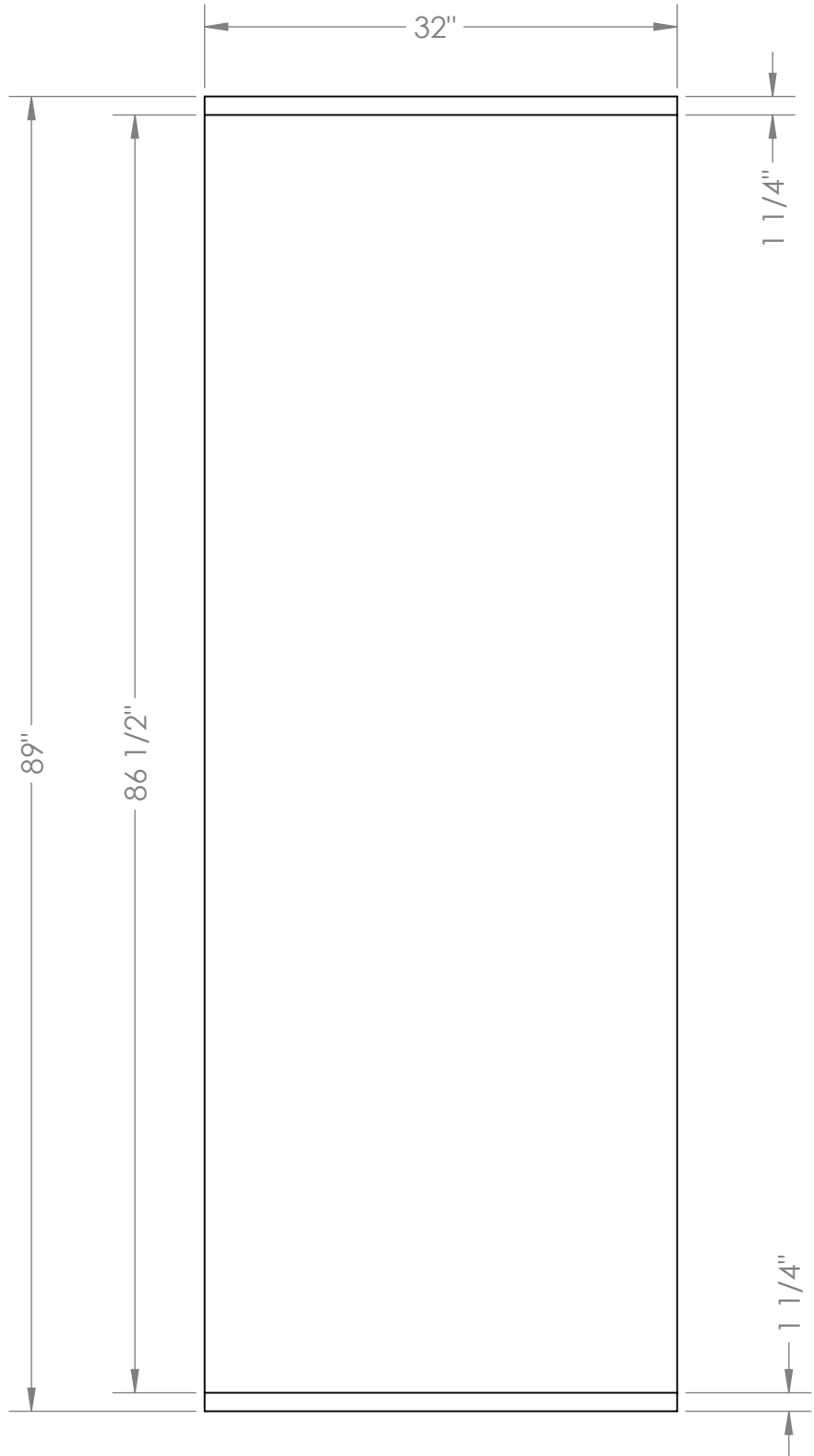

**PROPRIETARY AND CONFIDENTIAL**  
 THE INFORMATION CONTAINED IN THIS DRAWING IS THE SOLE PROPERTY OF <INSERT COMPANY NAME HERE>. ANY REPRODUCTION IN PART OR AS A WHOLE WITHOUT THE WRITTEN PERMISSION OF <INSERT COMPANY NAME HERE> IS PROHIBITED.

		UNLESS OTHERWISE SPECIFIED:		NAME	DATE			
		DIMENSIONS ARE IN INCHES		DRAWN	JC 05/14/2014			
		TOLERANCES:		CHECKED				
		FRACTIONAL ±		ENG APPR.				
		ANGULAR: MACH ± BEND ±		MFG APPR.				
		TWO PLACE DECIMAL ±		Q.A.				
		THREE PLACE DECIMAL ±		COMMENTS:				
		INTERPRET GEOMETRIC TOLERANCING PER:						
		MATERIAL						
NEXT ASSY	USED ON	FINISH						
APPLICATION		DO NOT SCALE DRAWING						
			<p align="center"><b>CUSTOM WALL PAD</b> 32" x 89"</p>					
						SIZE <b>B</b>	DWG. NO. <b>WP-32-89</b>	REV <b>03</b>
						SCALE: 1:16 WEIGHT:		SHEET 11 OF 13

8 7 6 5 4 3 2 1

8 7 6 5 4 3 2 1

Job# QTY.1

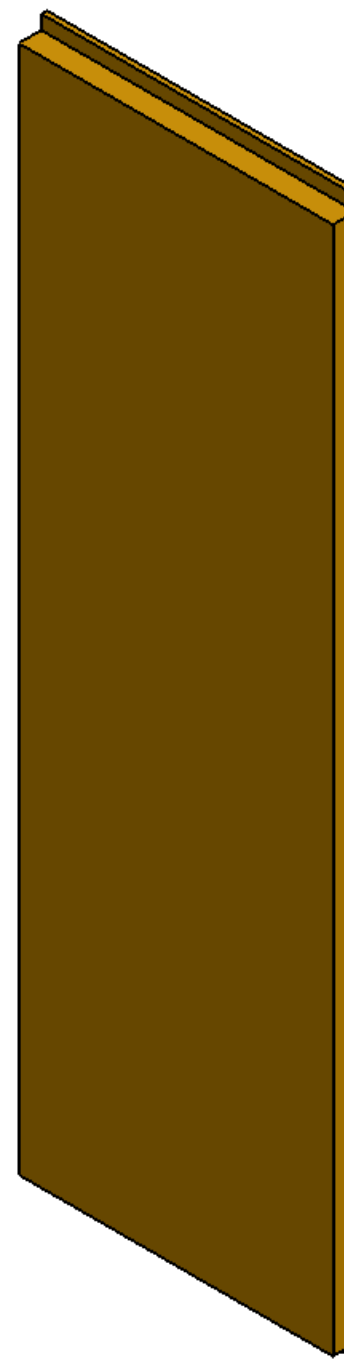
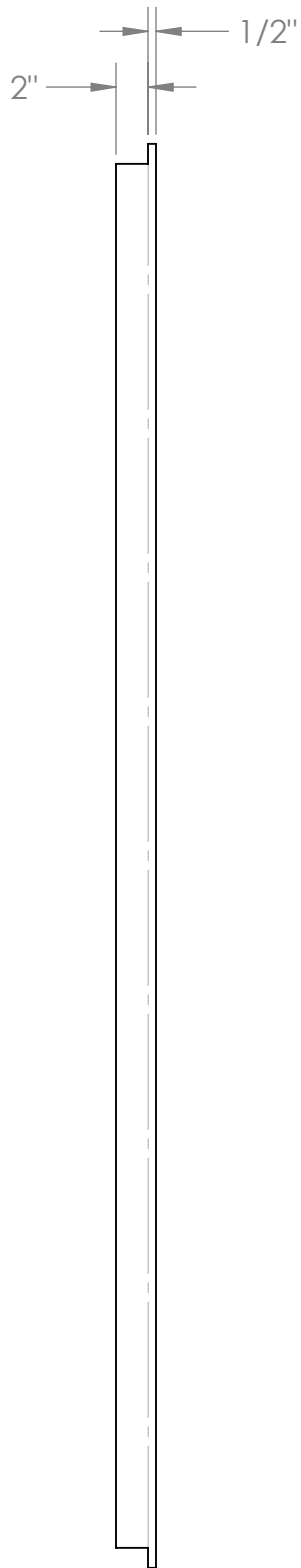
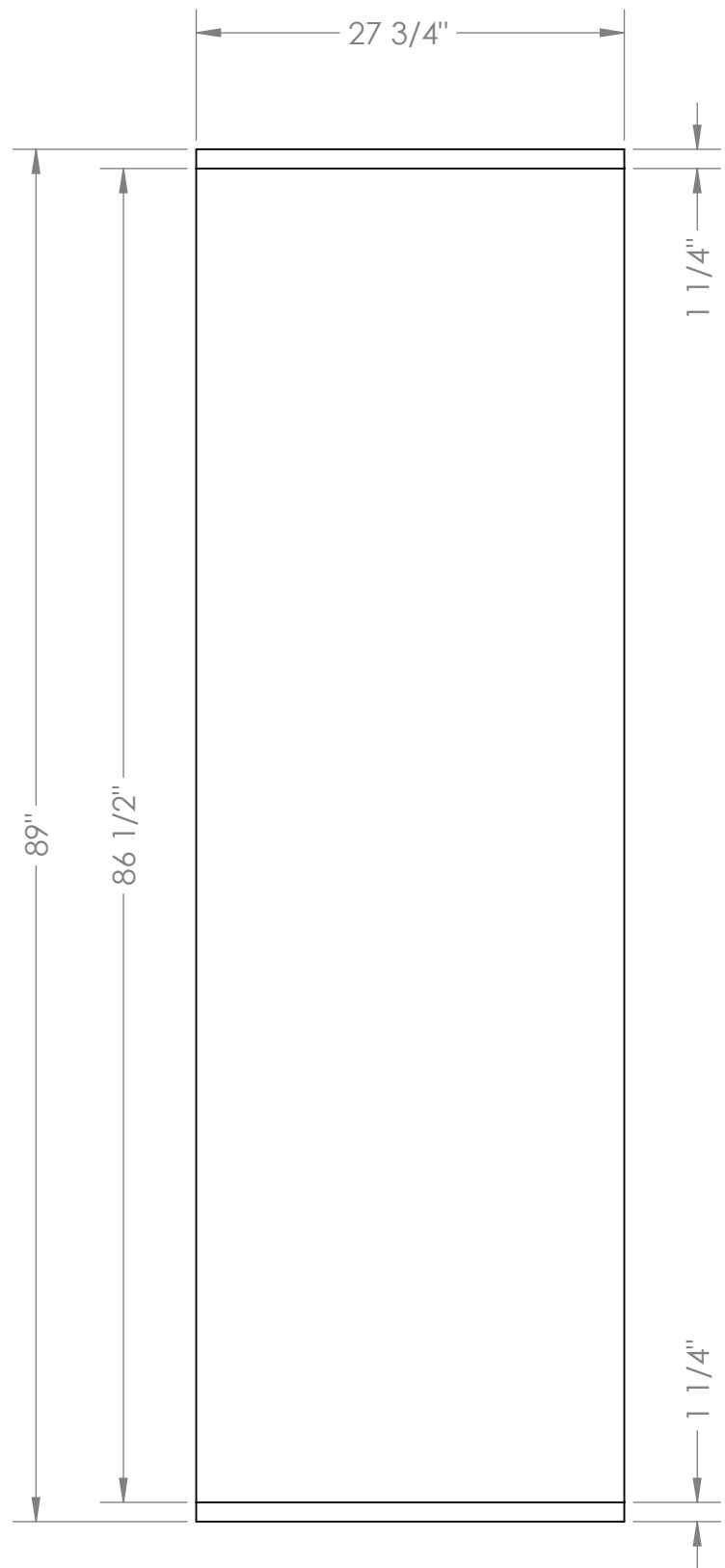

**PROPRIETARY AND CONFIDENTIAL**  
 THE INFORMATION CONTAINED IN THIS DRAWING IS THE SOLE PROPERTY OF <INSERT COMPANY NAME HERE>. ANY REPRODUCTION IN PART OR AS A WHOLE WITHOUT THE WRITTEN PERMISSION OF <INSERT COMPANY NAME HERE> IS PROHIBITED.

		UNLESS OTHERWISE SPECIFIED:		NAME	DATE
		DIMENSIONS ARE IN INCHES		DRAWN	JC 05/14/2014
		TOLERANCES:		CHECKED	
		FRACTIONAL ±		ENG APPR.	
		ANGULAR: MACH ± BEND ±		MFG APPR.	
		TWO PLACE DECIMAL ±		Q.A.	
		THREE PLACE DECIMAL ±		COMMENTS:	
		INTERPRET GEOMETRIC TOLERANCING PER:			
		MATERIAL			
NEXT ASSY	USED ON	FINISH			
APPLICATION		DO NOT SCALE DRAWING			
			<p align="center"><b>CUSTOM WALL PAD</b>          27-3/4" x 89"</p>		
			<b>B</b>	WP-27.75-89	03
			SCALE: 1:16	WEIGHT:	SHEET 12 OF 13

D  
C  
B  
A

D  
C  
B  
A

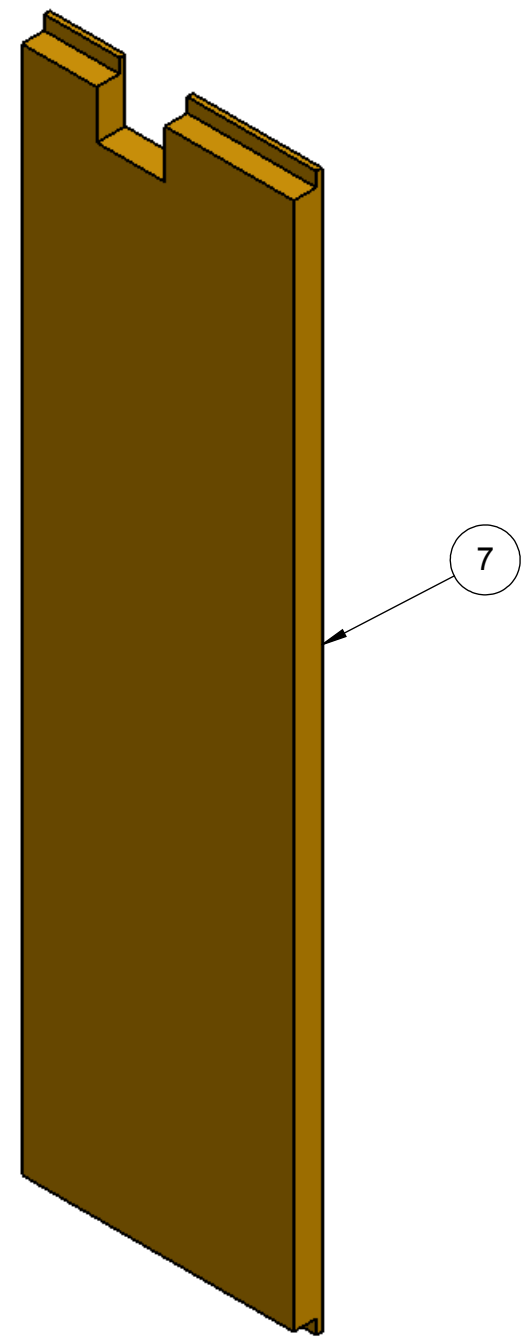
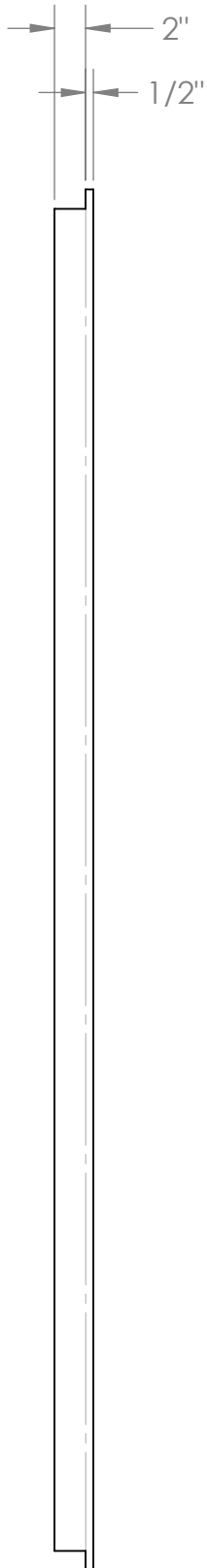
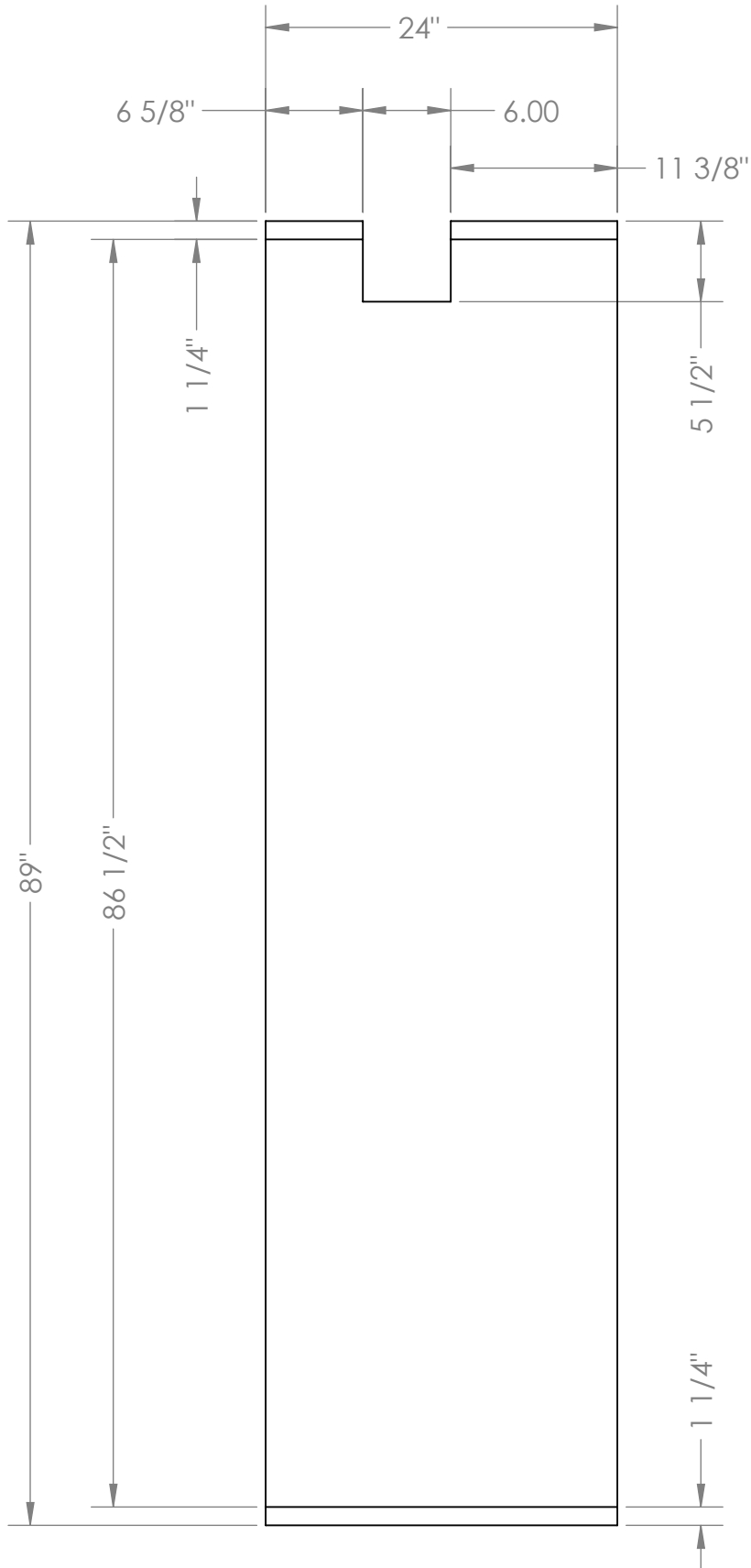

**PROPRIETARY AND CONFIDENTIAL**  
 THE INFORMATION CONTAINED IN THIS DRAWING IS THE SOLE PROPERTY OF <INSERT COMPANY NAME HERE>. ANY REPRODUCTION IN PART OR AS A WHOLE WITHOUT THE WRITTEN PERMISSION OF <INSERT COMPANY NAME HERE> IS PROHIBITED.

		UNLESS OTHERWISE SPECIFIED:		NAME	DATE
		DIMENSIONS ARE IN INCHES		DRAWN	JC 05/14/2014
		TOLERANCES:		CHECKED	
		FRACTIONAL ±		ENG APPR.	
		ANGULAR: MACH ± BEND ±		MFG APPR.	
		TWO PLACE DECIMAL ±		Q.A.	
		THREE PLACE DECIMAL ±		COMMENTS:	
		INTERPRET GEOMETRIC TOLERANCING PER:			
		MATERIAL			
NEXT ASSY	USED ON	FINISH			
APPLICATION		DO NOT SCALE DRAWING			
			<p align="center"><b>CUSTOM WALL PAD</b>                  24" x 89" WITH CUTOUT</p>		
			SCALE: 1:16 WEIGHT:		SHEET 13 OF 13

8 7 6 5 4 3 2 1

8 7 6 5 4 3 2 1