

SEATING PLAN

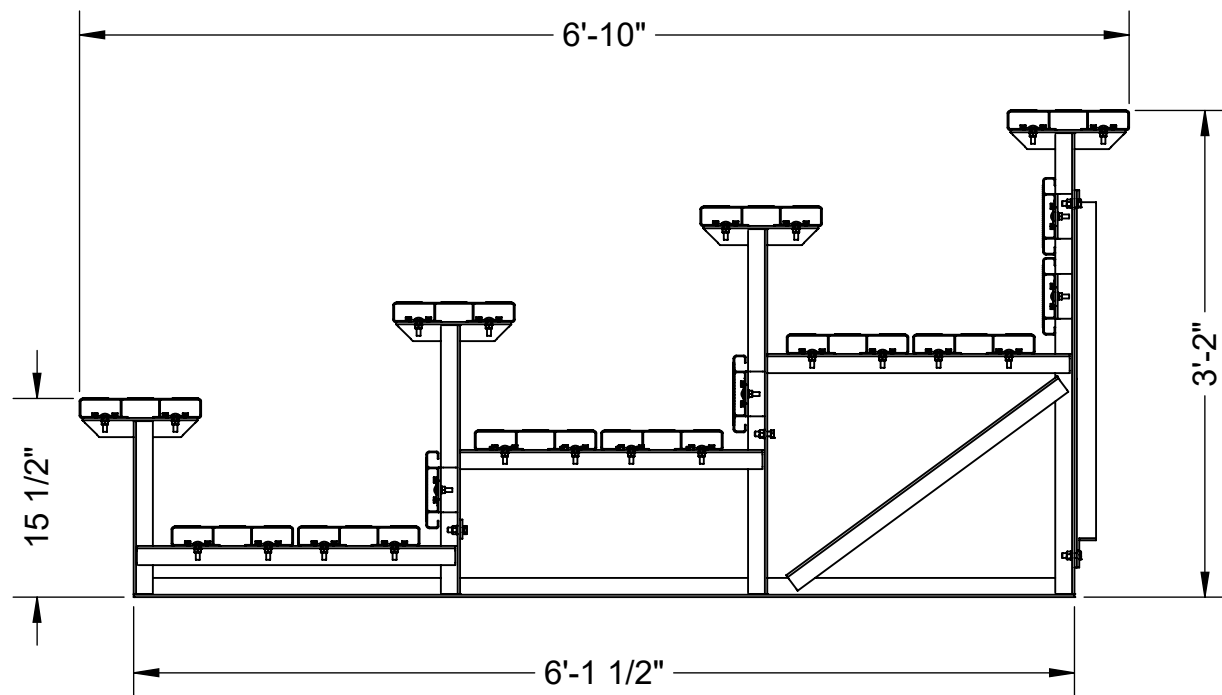

SECTION THROUGH BLEACHER SEATING

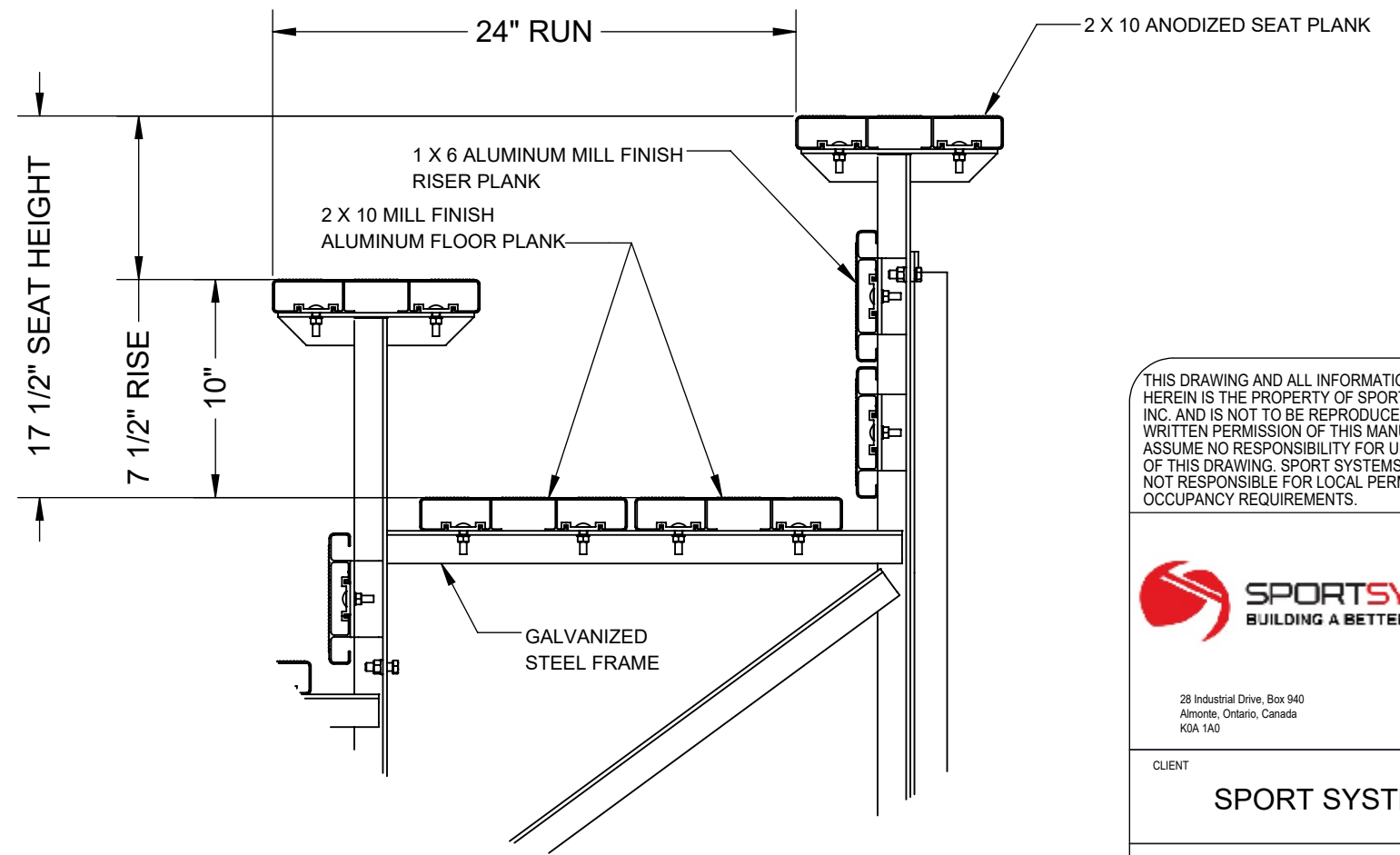

TYPICAL SEAT AND FLOOR BOARD DETAIL
NOT TO SCALE

REVISIONS			
REV.	DESCRIPTION	DATE	APPROVED

BENCH SEATS @ 18" PER SEAT = 32

THIS DRAWING AND ALL INFORMATION CONTAINED HEREIN IS THE PROPERTY OF SPORT SYSTEMS CANADA INC. AND IS NOT TO BE REPRODUCED WITHOUT THE WRITTEN PERMISSION OF THIS MANUFACTURER. WE ASSUME NO RESPONSIBILITY FOR UNAUTHORIZED USE OF THIS DRAWING. SPORT SYSTEMS CANADA INC. IS NOT RESPONSIBLE FOR LOCAL PERMITS AND OCCUPANCY REQUIREMENTS.



28 Industrial Drive, Box 940
Almonte, Ontario, Canada
K0A 1A0

www.ssci.ca
1.877.600.4667
T 613.256.1112
F 613.256.5876

CLIENT
SPORT SYSTEMS

TITLE
4 TIER BLEACHER 12' LONG

REV.	DATE	DWG No.
0	2023-05-19	BL-4TB-12DR

SCALE	DES.	PAGE
N.T.S.	JC	1 OF 1