

REVISIONS			
REV.	DESCRIPTION	DATE	APPROVED

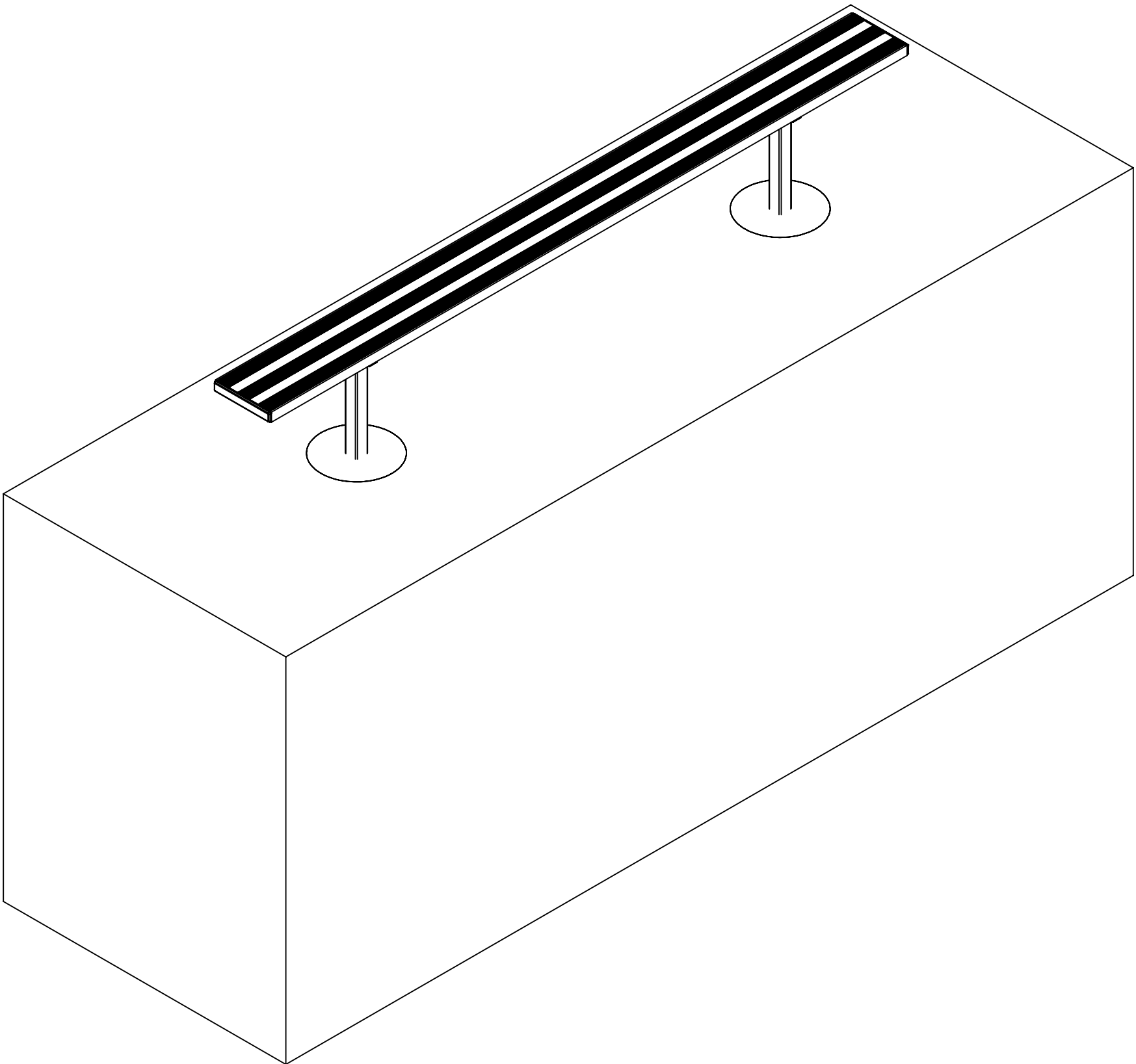

BL-IGB-9 FT. BENCH - SHOWN

THIS DRAWING AND ALL INFORMATION CONTAINED HEREIN IS THE PROPERTY OF SPORT SYSTEMS CANADA INC. AND IS NOT TO BE REPRODUCED WITHOUT THE WRITTEN PERMISSION OF THIS MANUFACTURER. WE ASSUME NO RESPONSIBILITY FOR UNAUTHORIZED USE OF THIS DRAWING. SPORT SYSTEMS CANADA INC. IS NOT RESPONSIBLE FOR LOCAL PERMITS AND OCCUPANCY REQUIREMENTS.



28 Industrial Drive, Box 940  
Almonte, Ontario, Canada  
K0A 1A0

www.ssci.ca  
1.877.600.4667  
T 613.256.1112  
F 613.256.5876

CLIENT  
**SPORT SYSTEMS**

TITLE  
**BL-IGB-9 FT.**

REV.	DATE	DWG No:
	2017-06-22	BL-IGB-9
SCALE	DES.	PAGE
N.T.S.	BAT	1 OF 5

ITEM NO.	PART NUMBER	DESCRIPTION	QTY.
1	AL-16723A-9	2" X 10" NOMINAL BLEACHER PLANK - ANODIZED FINISH - 9'-0"	1
2	BL-20774	RETAINER CLIP - ALUMINUM	4
3	BL-EC16723	MOLDED END CAP-INSERT-BLACK POLYCARBONATE	2
4	BL-IGB ASSY.	IN - GROUND BENCH STRINGER	2
5	HW-B-50005	5/16" x 1-1/4" HDG, GR 2 CARRIAGE BOLT	4
6	HW-N-10002	5/16" HDG. GR,2 HEX NUT	4
7	HW-R-10000	ALUMINUM POP RIVET 3/16" x 0.251-0.375	4
8	HW-W-20002	5/16" LOCK WASHER, HDG.	4

REVISIONS			
REV.	DESCRIPTION	DATE	APPROVED

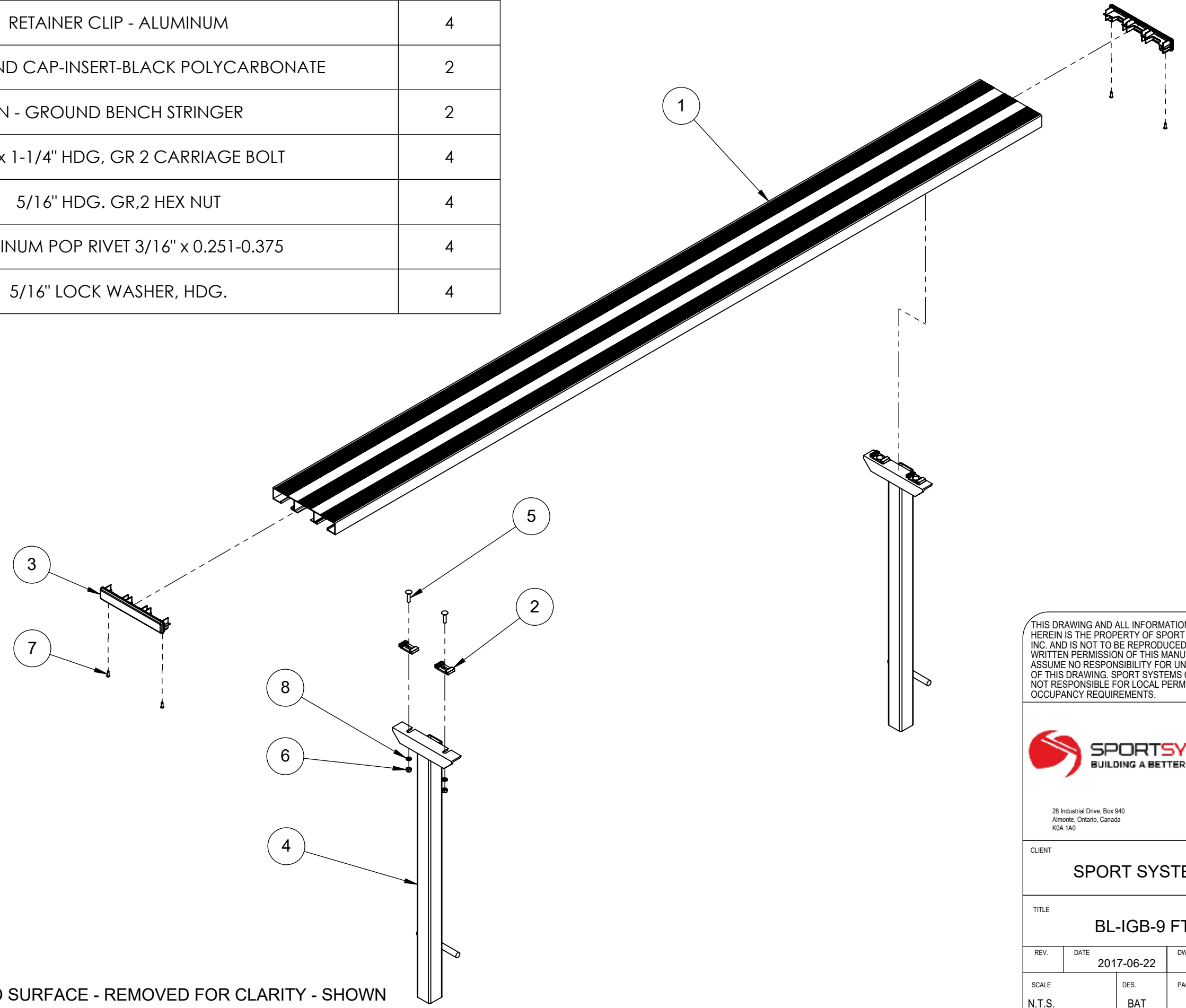

THIS DRAWING AND ALL INFORMATION CONTAINED HEREIN IS THE PROPERTY OF SPORT SYSTEMS CANADA INC. AND IS NOT TO BE REPRODUCED WITHOUT THE WRITTEN PERMISSION OF THIS MANUFACTURER. WE ASSUME NO RESPONSIBILITY FOR UNAUTHORIZED USE OF THIS DRAWING. SPORT SYSTEMS CANADA INC. IS NOT RESPONSIBLE FOR LOCAL PERMITS AND OCCUPANCY REQUIREMENTS.



28 Industrial Drive, Box 940  
Almonte, Ontario, Canada  
K0A 1A0

www.ssci.ca  
1.877.600.4667  
T 613.256.1112  
F 613.256.5876

CLIENT  
**SPORT SYSTEMS**

TITLE  
**BL-IGB-9 FT.**

REV.	DATE	DWG No:
	2017-06-22	BL-IGB-9

SCALE	DES.	PAGE
N.T.S.	BAT	2 OF 5

BL-IGB-9 FT. BENCH - CONCRETE PIER AND GROUND SURFACE - REMOVED FOR CLARITY - SHOWN

REVISIONS			
REV.	DESCRIPTION	DATE	APPROVED

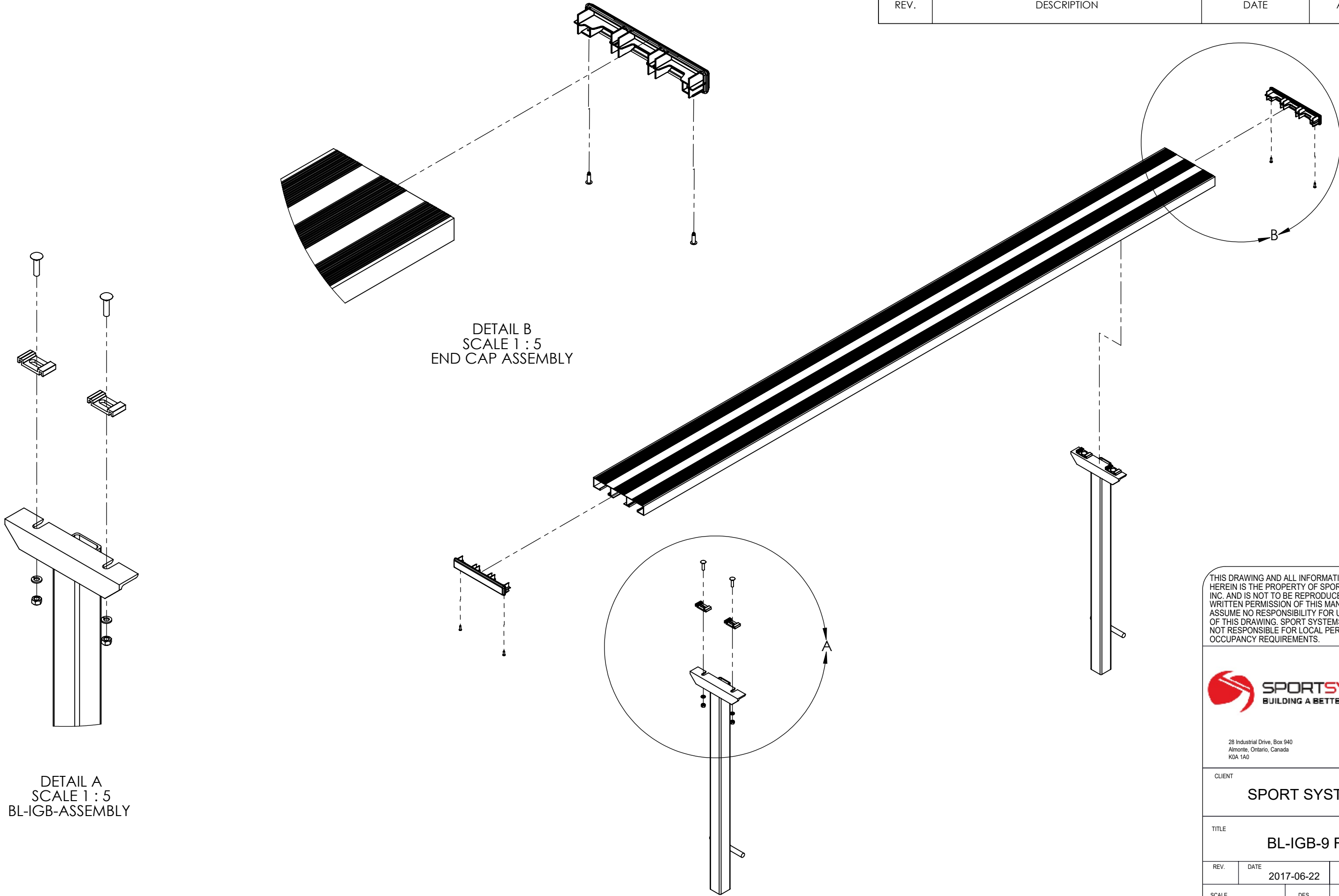

DETAIL B  
SCALE 1 : 5  
END CAP ASSEMBLY

DETAIL A  
SCALE 1 : 5  
BL-IGB-ASSEMBLY

BL-IGB-9 FT. BENCH - EXPLODED VIEW - SHOWN

THIS DRAWING AND ALL INFORMATION CONTAINED HEREIN IS THE PROPERTY OF SPORT SYSTEMS CANADA INC. AND IS NOT TO BE REPRODUCED WITHOUT THE WRITTEN PERMISSION OF THIS MANUFACTURER. WE ASSUME NO RESPONSIBILITY FOR UNAUTHORIZED USE OF THIS DRAWING. SPORT SYSTEMS CANADA INC. IS NOT RESPONSIBLE FOR LOCAL PERMITS AND OCCUPANCY REQUIREMENTS.



28 Industrial Drive, Box 940  
Almonte, Ontario, Canada  
K0A 1A0

www.ssci.ca  
1.877.600.4667  
T 613.256.1112  
F 613.256.5876

CLIENT  
**SPORT SYSTEMS**

TITLE  
**BL-IGB-9 FT.**

REV.	DATE	DWG No:
	2017-06-22	BL-IGB-9

SCALE	DES.	PAGE
N.T.S.	BAT	3 OF 5

REVISIONS			
REV.	DESCRIPTION	DATE	APPROVED

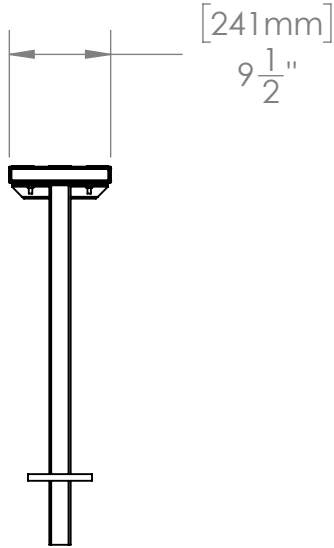
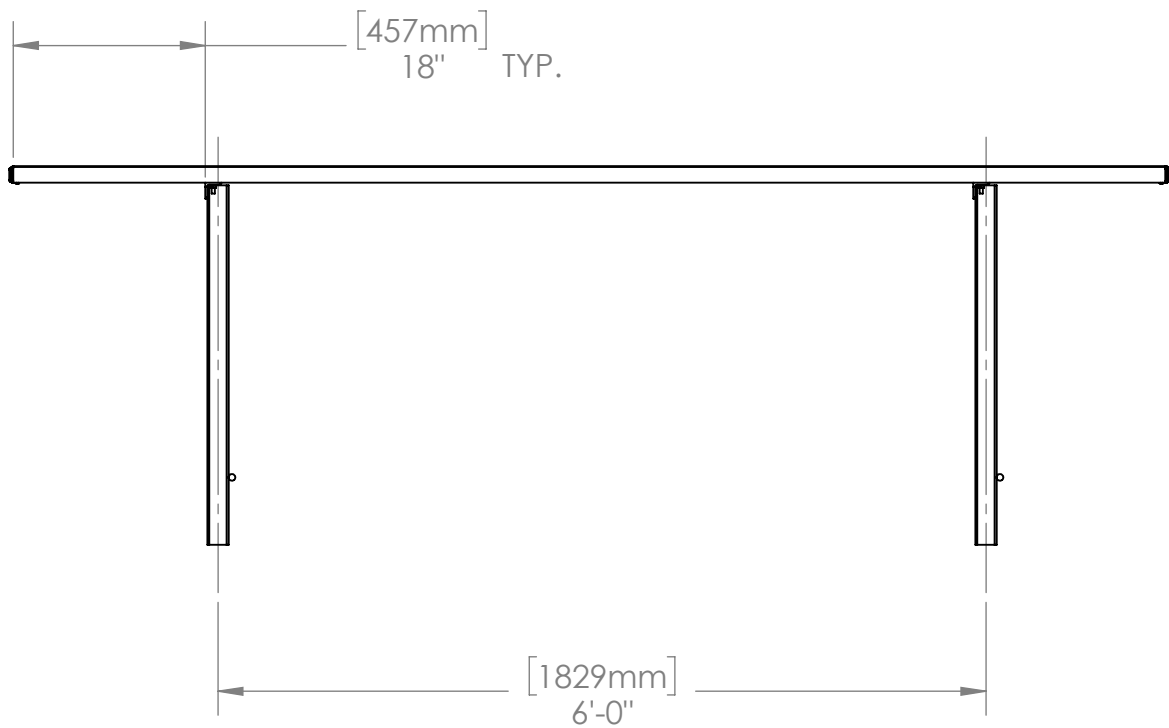
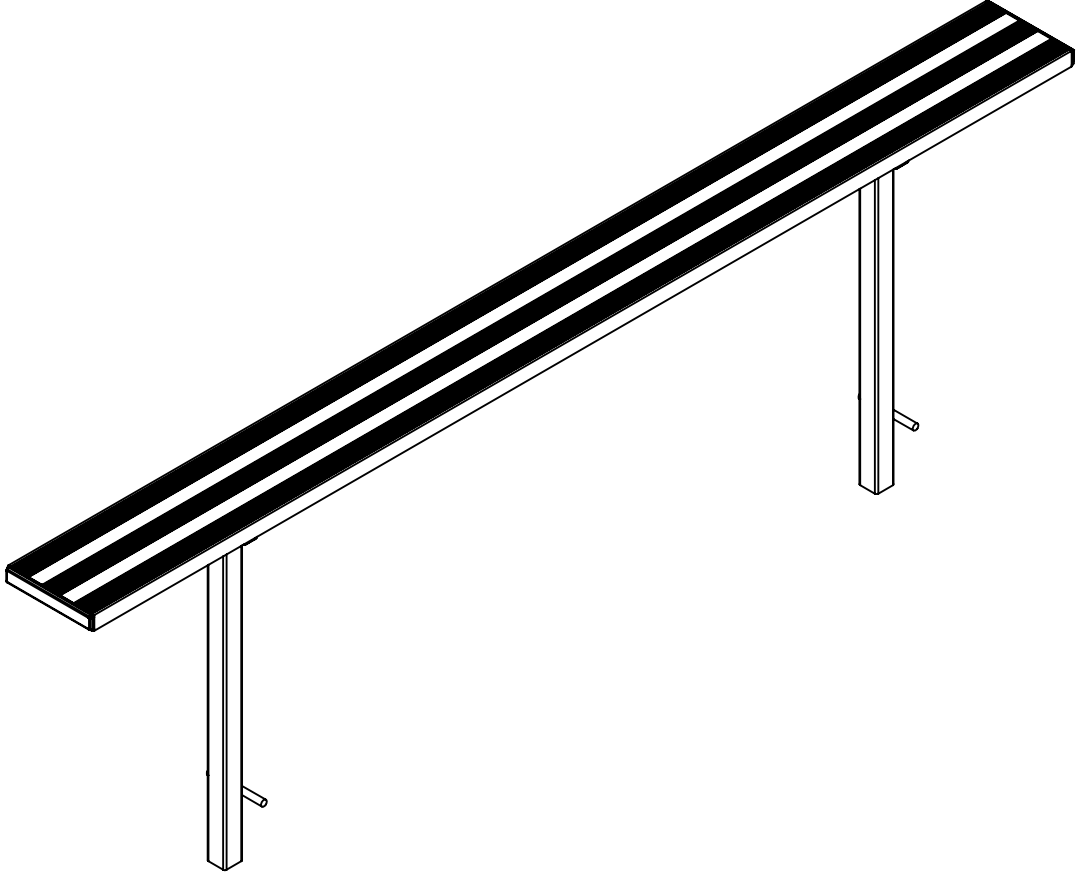
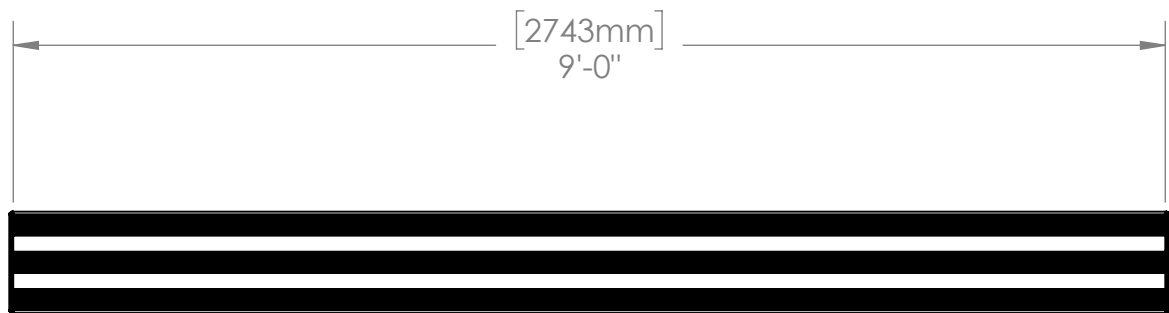

THIS DRAWING AND ALL INFORMATION CONTAINED HEREIN IS THE PROPERTY OF SPORT SYSTEMS CANADA INC. AND IS NOT TO BE REPRODUCED WITHOUT THE WRITTEN PERMISSION OF THIS MANUFACTURER. WE ASSUME NO RESPONSIBILITY FOR UNAUTHORIZED USE OF THIS DRAWING. SPORT SYSTEMS CANADA INC. IS NOT RESPONSIBLE FOR LOCAL PERMITS AND OCCUPANCY REQUIREMENTS.



28 Industrial Drive, Box 940  
Almonte, Ontario, Canada  
K0A 1A0

www.ssci.ca  
1.877.600.4667  
T 613.256.1112  
F 613.256.5876

CLIENT  
**SPORT SYSTEMS**

TITLE  
**BL-IGB-9 FT.**

REV.	DATE	DWG No:
	2017-06-22	BL-IGB-9

SCALE	DES.	PAGE
N.T.S.	BAT	4 OF 5

BL-IGB-9 FT. BENCH - SPACING LAYOUT - GROUND AND FOOTINGS ARE REMOVED FOR CLARITY- SHOWN

REVISIONS			
REV.	DESCRIPTION	DATE	APPROVED

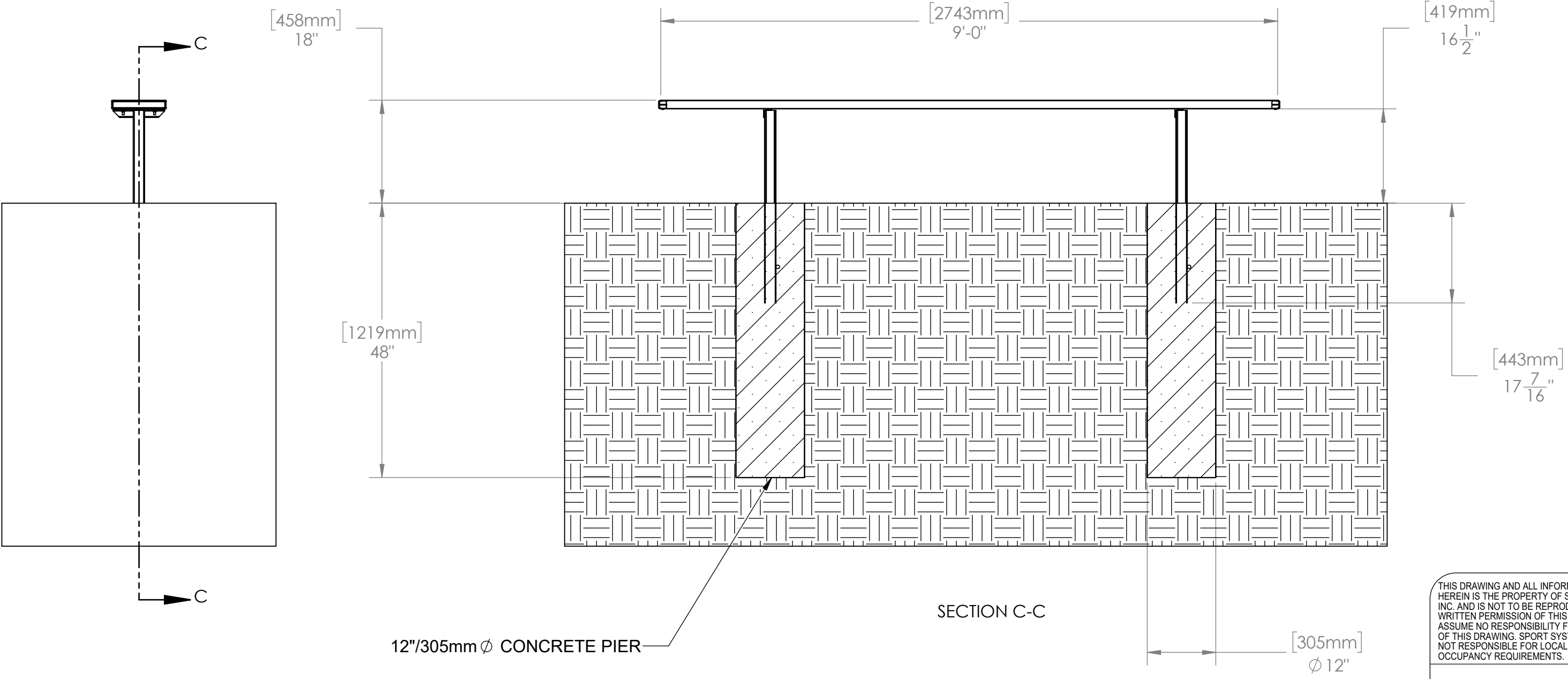

NOTES: (1) BL-IGB-9 - ASSEMBLED AT SITE - SHOWN  
 (2) EXCAVATE FOOTINGS AS DETAILED ON DRAWING ARE FOR REFERENCE ONLY. FOOTING SIZE AND DEPTH MAY REQUIRE ALTERATION PENDING GEOGRAPHICAL LOCATION AND PROPENSITY FOR FROST HEAVE IN SPECIFIC GEOGRAPHIC LOCATIONS. FOOTING CHARACTERISTICS MAY ALSO BE DETERMINED BY OWNER OR CONSULTANT'S RECOMMENDATIONS. SSCI IS NOT RESPONSIBLE FOR ANY ISSUE RELATING TO FROST HEAVE OR IMPROPER INSTALLATION. FOOTINGS DETAILS ARE SHOWN AS A GUIDELINE ONLY AND IT'S RECOMMENDED THAT THE BUYER CONSULT WITH LOCAL BUILDING OFFICIAL TO DETERMINE THE SUITABILITY OF ANY FOOTING POURED.

THIS DRAWING AND ALL INFORMATION CONTAINED HEREIN IS THE PROPERTY OF SPORT SYSTEMS CANADA INC. AND IS NOT TO BE REPRODUCED WITHOUT THE WRITTEN PERMISSION OF THIS MANUFACTURER. WE ASSUME NO RESPONSIBILITY FOR UNAUTHORIZED USE OF THIS DRAWING. SPORT SYSTEMS CANADA INC. IS NOT RESPONSIBLE FOR LOCAL PERMITS AND OCCUPANCY REQUIREMENTS.



28 Industrial Drive, Box 940  
 Almonte, Ontario, Canada  
 K0A 1A0

www.ssci.ca  
 1.877.600.4667  
 T 613.256.1112  
 F 613.256.5876

CLIENT  
**SPORT SYSTEMS**

TITLE  
**BL-IGB-9 FT.**

REV.	DATE	DWG No:
	2017-06-22	BL-IGB-9
SCALE	DES.	PAGE
N.T.S.	BAT	5 OF 5