

SEATING PLAN

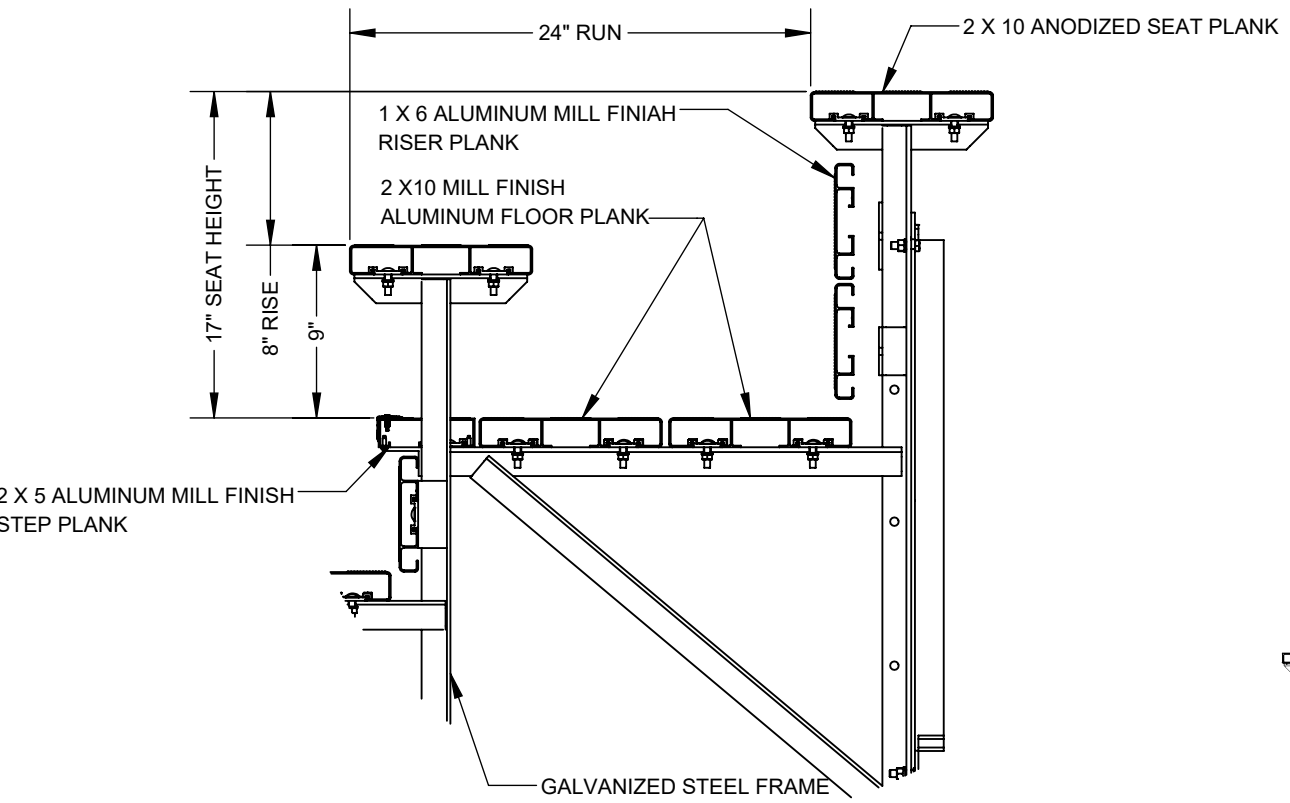

TYPICAL SEAT AND FLOOR BOARD DETAIL
NOT TO SCALE

BENCH SEATS @ 18" PER SEAT = 68

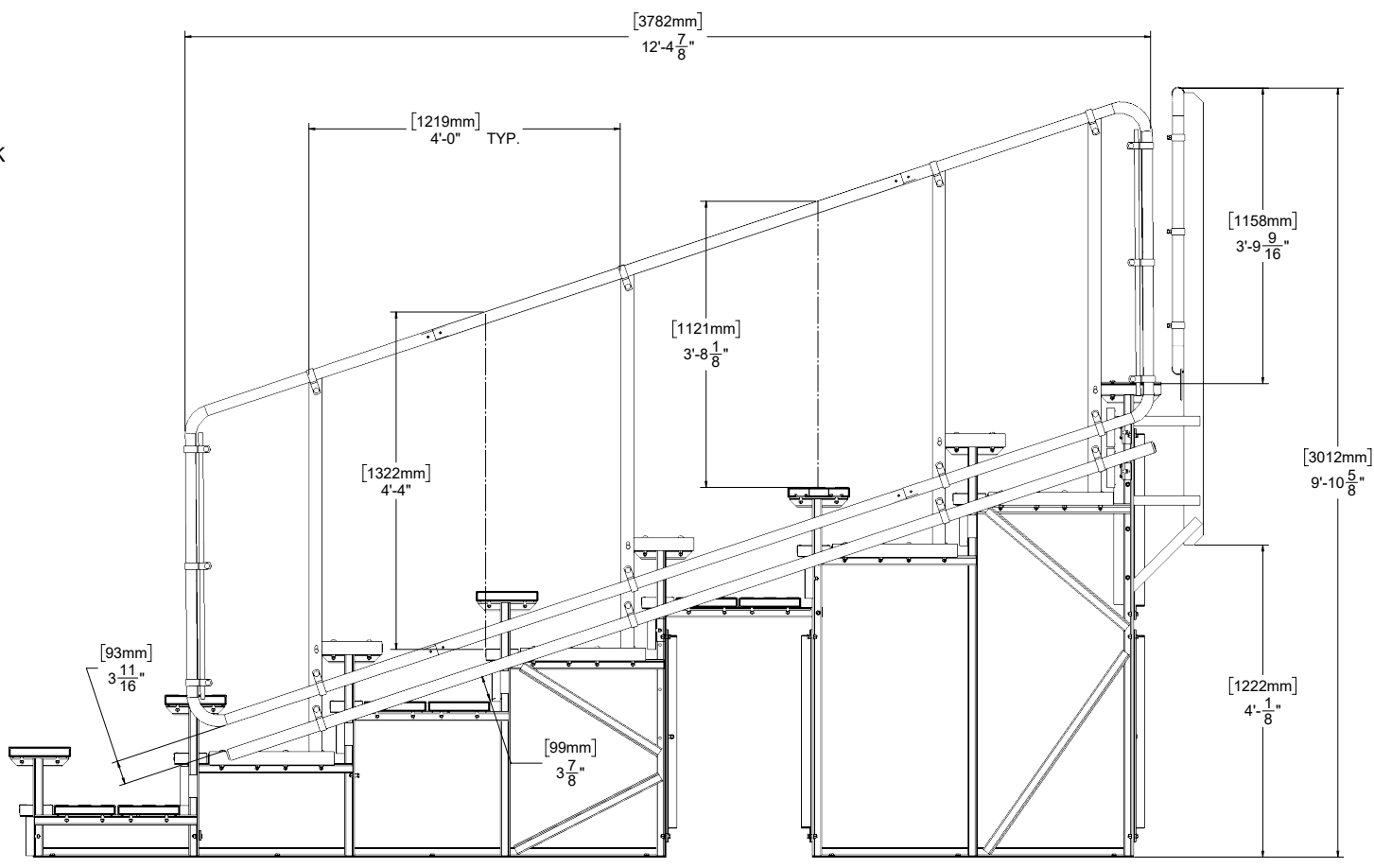
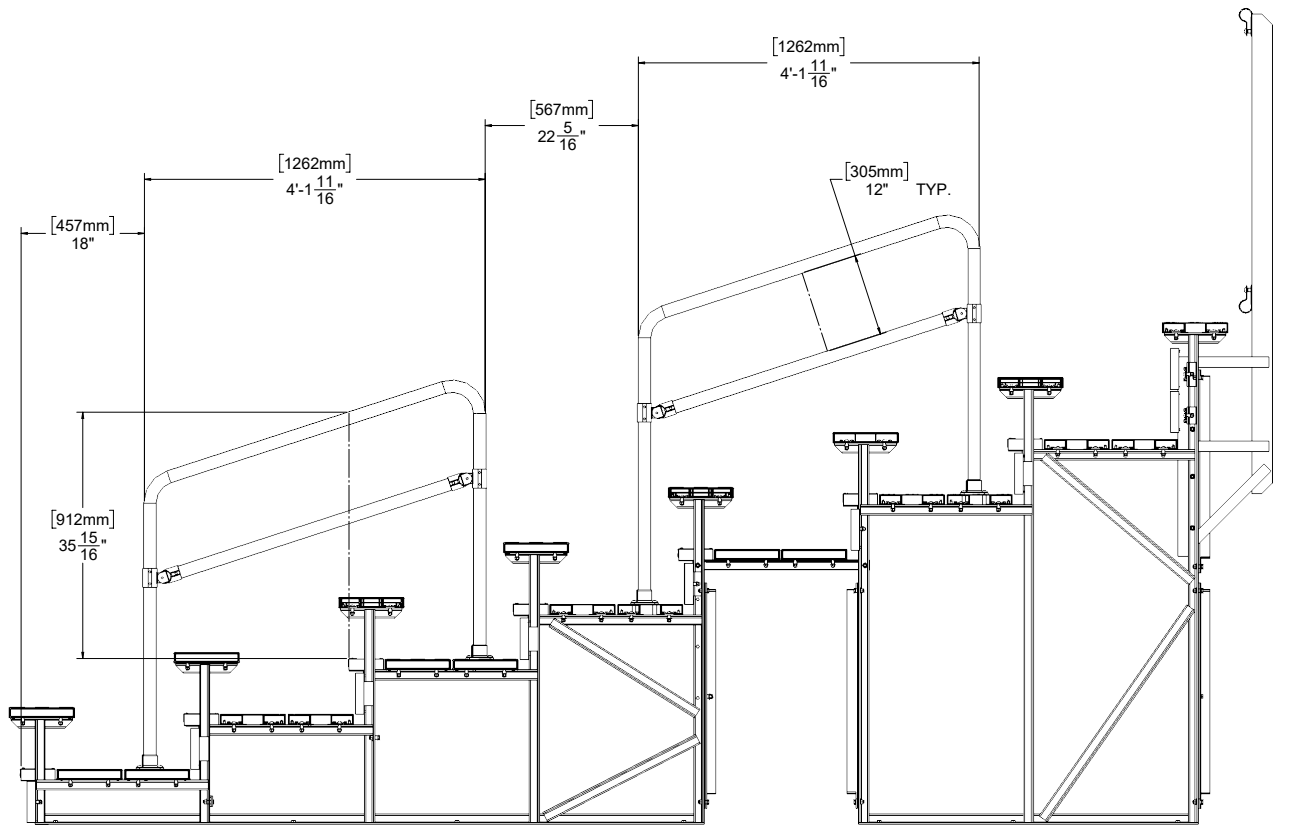

SECTION THROUGH BLEACHER SEATING
NOTE: CHAIN LINK REMOVED FOR CLARITY.

REVISIONS			
REV.	DESCRIPTION	DATE	APPROVED

THIS DRAWING AND ALL INFORMATION CONTAINED HEREIN IS THE PROPERTY OF SPORT SYSTEMS CANADA INC. AND IS NOT TO BE REPRODUCED WITHOUT THE WRITTEN PERMISSION OF THIS MANUFACTURER. WE ASSUME NO RESPONSIBILITY FOR UNAUTHORIZED USE OF THIS DRAWING. SPORT SYSTEMS CANADA INC. IS NOT RESPONSIBLE FOR LOCAL PERMITS AND OCCUPANCY REQUIREMENTS.



28 Industrial Drive, Box 940
Almonte, Ontario, Canada
K0A 1A0
www.ssci.ca
1.877.600.4667
T 613.256.1112
F 613.256.5876

CLIENT
SPORT SYSTEMS

TITLE
**8 TIER BLEACHER 8" RISE 24" RUN
DOUBLE FOOT BOARD WITH STAIR AISLE**

REV. 01	DATE 2025-11-21	DWG No. BL-8TB-18-8-24-PLT
SCALE N.T.S.	DES. DH	PAGE 1 OF 1